

Tonellidesign

The New Modernism
2024 Collection

Tonellidesign

The New Modernism. Collection 2024

La nuova collezione 2024 è l'evoluzione, il coerente seguito, di una strada intrapresa da diversi anni che rinnova ed accresce la storia del marchio Tonelli e la sua originaria vocazione al design. Affinità e contrasti, giochi e relazioni di forme e materie che, con i loro delicati equilibri, connotano il mood della nostra casa. The New Modernism è la nostra interpretazione dell'abitare contemporaneo, il senso che cogliamo dell'evoluzione del gusto e degli stili di vita, sommando tra loro la razionale eleganza del design e l'interpretazione della forte espressività delle materie naturali. Contemporaneità oltre ogni tendenza, reale e senza tempo, uno stile di vita internazionale, libero e personale che ben si adatta alle case di tutto il mondo.

Il vetro è l'elemento che amiamo, è il filo conduttore di una collezione multimaterica, usato esplorando le sue grandi potenzialità, le sue varie vesti, i suoi molteplici significati e le sue anime sottili. Il nostro vetro è quello delle classiche trasparenze eteree e brillanti, quello caldo e affascinante dei vetri colorati, quello fuso tridimensionale della collezione 2024, attuale e decorativo con le sue diverse texture. Un vetro inaspettato che dichiara con le sue naturali imperfezioni la sua anima artigianale, viva ed emozionante, per sperimentare una nuova esperienza esclusiva.

The new collection 2024 is the evolution, the coherent sequel, of a path taken several years ago, that renovates and expands the history of the Tonelli brand and its original vocation for design. Affinity and contrasts, interplay and relationships of shapes and materials that, with their delicate equilibria, denote the mood of our house. The New Modernism is our interpretation of contemporary living, the meaning we catch of the evolution of taste and lifestyles, adding up the elegance of design and the interpretation of the great expressivity of natural materials. Contemporaneity beyond any trend, real and timeless, an international lifestyle, free and personal that easily adapts to homes all around the world.

Glass is the element we love, the leitmotif of a multimaterial collection, used exploring its vast potential, its various looks, its multiple meanings and its fine souls. Our glass is that of the classical ethereal and shiny transparencies, the warmth and appeal of coloured glass, the three-dimensional fused one of collection 2024, current and decorative with its different textures. An unexpected glass that declares with its natural imperfections its craftsmanship soul, alive and exciting, able to explore a new exclusive experience.

Scenery and products index

Indice
composizioni
e prodotti

Scenery index Indice composizioni

SC015 8

Bow	10
Hyperion	20
Aterea	26
Split	38

SC016 48

Soft Glass	50
Lilypad	56
Iris	60
Quiller	66

SC017 72

Pleat	74
Mit	82
Bands	88

SC018 94

Farniente	96
Liber M	102

SC019 108

Penrose	110
Dekon	116

Products index Indice prodotti

Tavoli alti Dining tables

Bow	10
Pleat	74
Farniente	96

Madie Sideboards

Aterea	26
Liber M	102

Sedie Chairs

Mit	82
-----	----

Tavoli bassi Coffee tables

Lilypad	56
Dekon	116
Farniente	96

Console, desk Console, desk

Penrose	110
---------	-----

Lampade Lamps

Hyperion	20
----------	----

Librerie Bookcases

Quiller	66
---------	----

Divano Sofa

Soft Glass	50
------------	----

Specchi Mirrors

Iris	60
Split	38
Bands	88



SC015

Bow Tavolo / Table
Vetro fumè, vetro T-Squares fumè
Smoked glass, T-Squares smoked glass

AW_chair Sedia / Chair
Siberian ash, tessuto P 503
Siberian ash, fabric P 503

Hyperion Lampada / lamp
Champagne metallizzato, vetro pyrex
soffiato trasparente
Metallic champagne, transparent
blown pyrex glass

Split Specchio / Mirror
Specchio, specchio fumè
Mirror, smoked mirror

Aterea Madia / Sideboard
Vetro satinato Titanio, specchio fumè, vetro fumè
Frosted Titanio glass, smoked mirror, smoked glass



Bow
dining table

design
Massimo Castagna

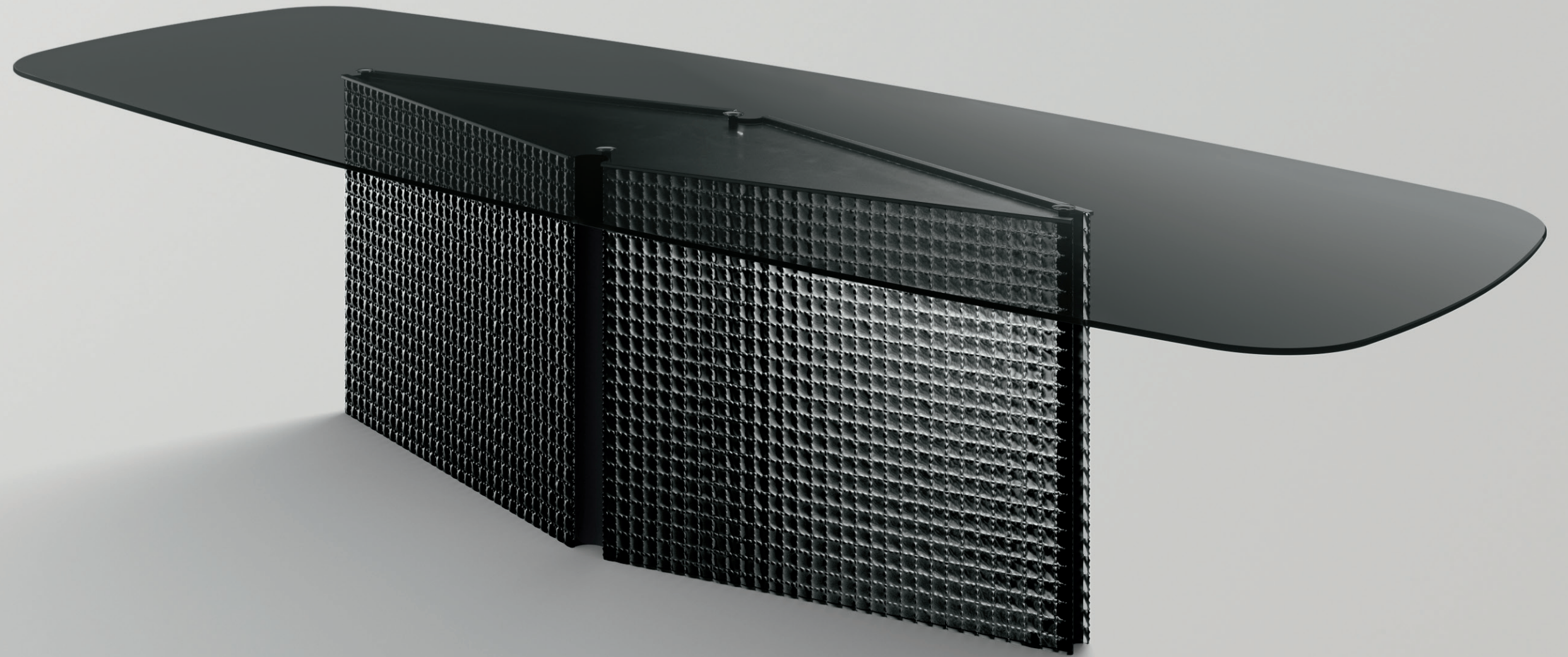

Le linee eleganti e contemporanee dei piani si abbinano alla base dal volume geometrico in vetro fuso, creando un equilibrio di forme perfetto e originale. Il contrasto delle finiture tra il top e la base genera un incontro materico autentico e armonioso. La cura degli elementi di collegamento in metallo della base, li rende dettagli unici e raffinati.

The elegant and contemporary lines of the tops merge with the geometric volume of the base in fused glass, creating a perfect and original balance of shapes. The contrast of the top and base finishes generates an authentic and harmonic textural encounter. The attentive care for the connecting metallic elements of the base make them unique and refined details.

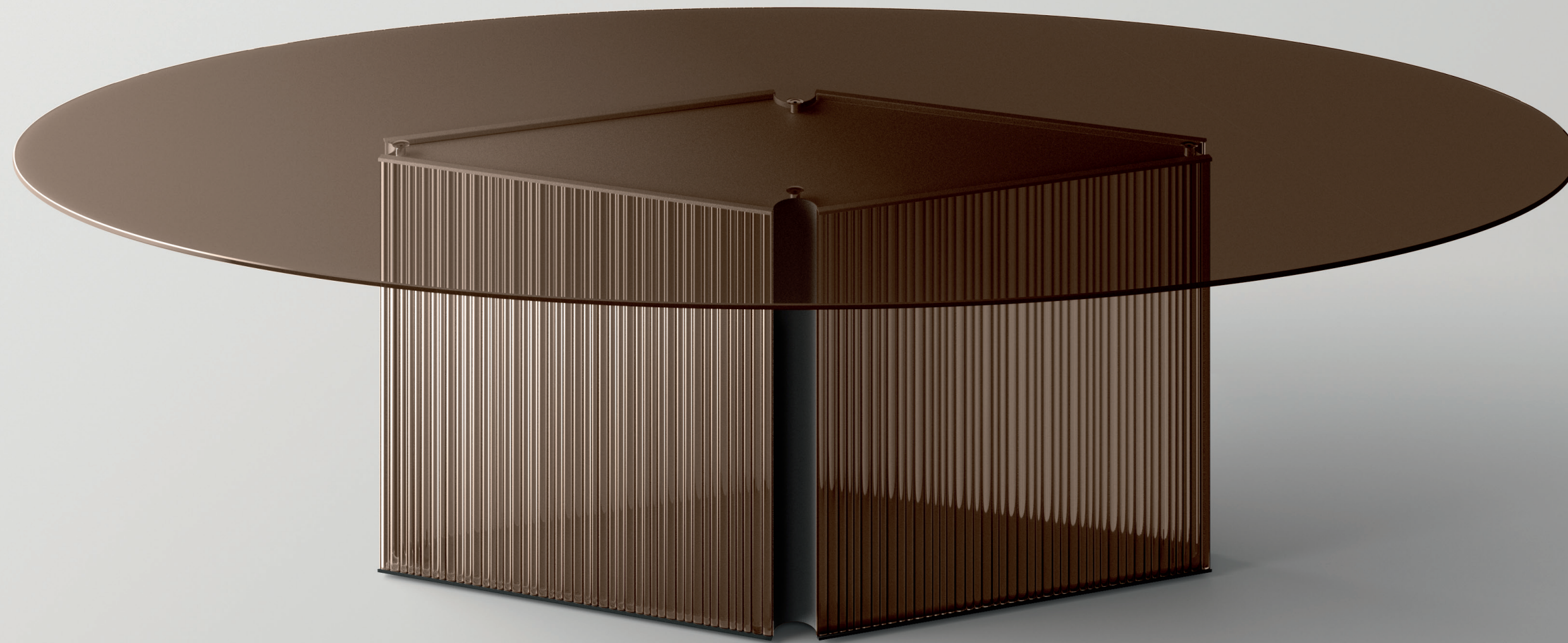

Un processo di fusione ad alta temperatura dà vita ad un materiale che racconta del dialogo tra artigianalità e ricerca moderna. T-Squares e T-Stripes sono textures impresse in profondità nella lastra di vetro che assume così un aspetto visivo denso e sinuoso.

A process of fusion at high temperature creates a material that shares the dialogue between craftsmanship and modern research. T-Squares and T-Stripes are profoundly embossed textures of the glass slabs, that adopt a dense and sinuous visual appearance.

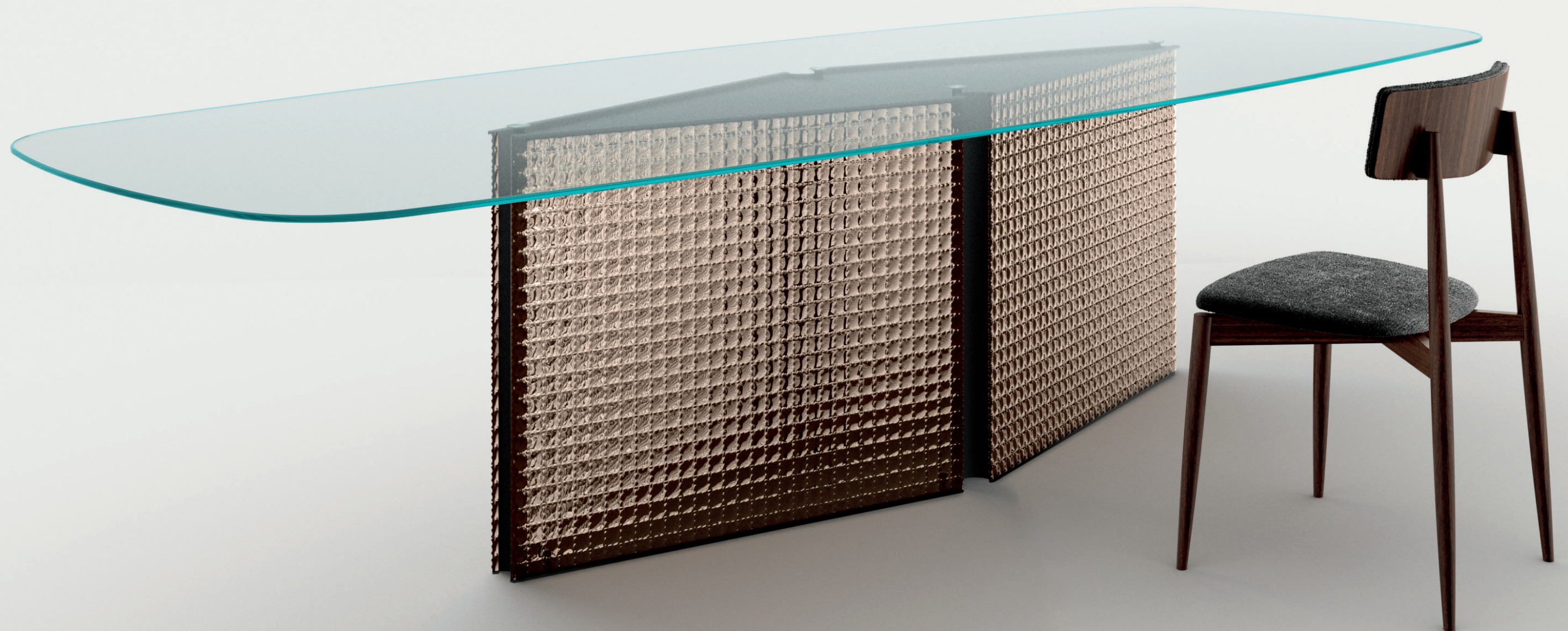





Bow dining table

design
Massimo Castagna

Info Tecniche / Technical Info

Tavolo con piano in vetro temperato rettangolare, sagomato o ellittico, disponibile nelle finiture extra-chiaro, fumè o bronzo, fissato alla base tramite piastre di acciaio. Il basamento centrale è composto da elementi verticali in vetro fuso, nelle varianti T-Squares e T-Stripes, finitura fumè o bronzo. Gli elementi in metallo del basamento sono in finitura nero opaco. I piedini regolabili in altezza, nascosti sotto la base, permettono un perfetto livellamento del tavolo.

Table with top in tempered glass rectangular, shaped or elliptical, available in extra clear, smoked or bronze finish, fixed to the base through steel plates. The central base is made of vertical elements in fused glass, available in variation T-Squares and T-Stripes, smoked or bronze finish. The metal elements of the base are in matt black finish. Height adjustable small feet, hidden under the base, allow a perfect levelling of the table.

Piano / Top
280x110
320x120

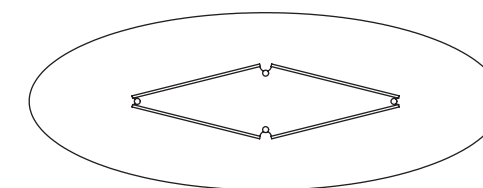

Piano / Top
200x110
220x110
240x110
260x110
280x110
300x110
320x120

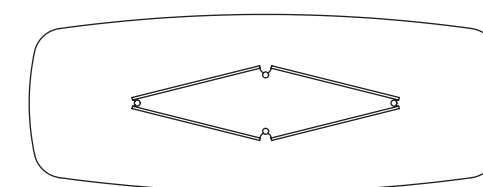

Piano / Top
200x100
220x100
240x100
260x100
280x100
300x100
320x120

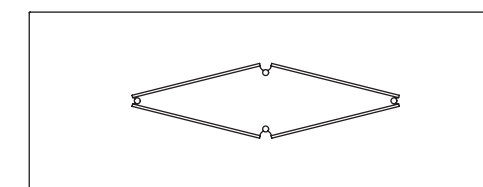

•
75
•

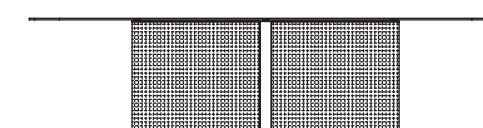

Hyperion lamp

design
Massimo Castagna

L'ampia famiglia di lampade Hyperion si arricchisce della nuova finitura champagne per la struttura e di una nuova versione sospesa orizzontale, pensata in abbinamento a tavoli da pranzo rettangolari, per un perfetto equilibrio di volumi ed un ottimale effetto luminoso.

The large family of the Hyperion lamps grows with the new champagne finish for the structure and a new horizontal hanging version, thought to match with rectangular dining tables for a perfect balance of volumes and an optimal light effect.



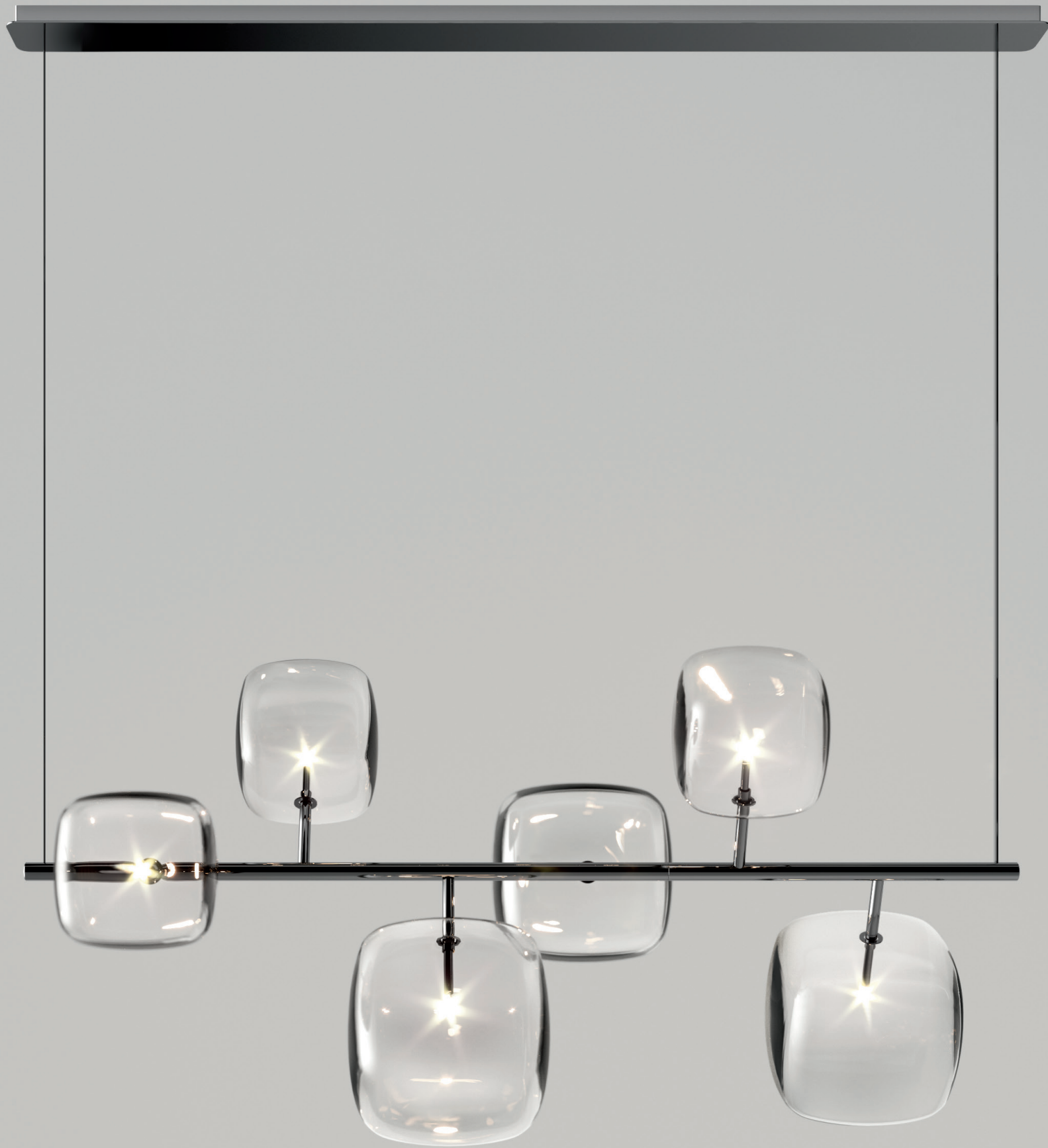



Hyperion lamp

design
Massimo Castagna

Info Tecniche / Technical Info

Collezione di lampade con luce LED G4 o G9 3000K e lampadina dimmerabile. Cubi in vetro pyrex soffiato trasparente. Parti metalliche disponibili nelle finiture cromo lucido, oro lucido, canna di fucile lucido e champagne. L'altezza delle sospensioni può essere realizzata a misura.

Collection of lamps with LED light G4 or G9 3000K and dimmable bulb. Cubes in transparent blown Pyrex glass. Metal parts available in polished chrome, polished gold, polished gunmetal and champagne. Height of hanging lamps can be customized.

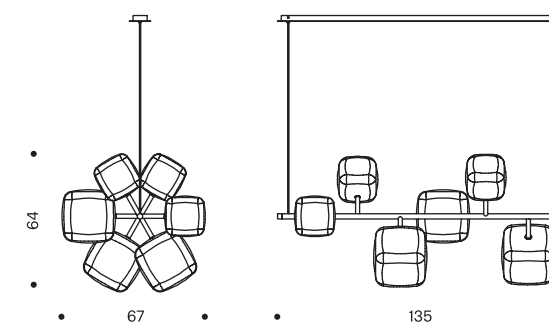

Aterea
sideboard

design
Tonelli design studio

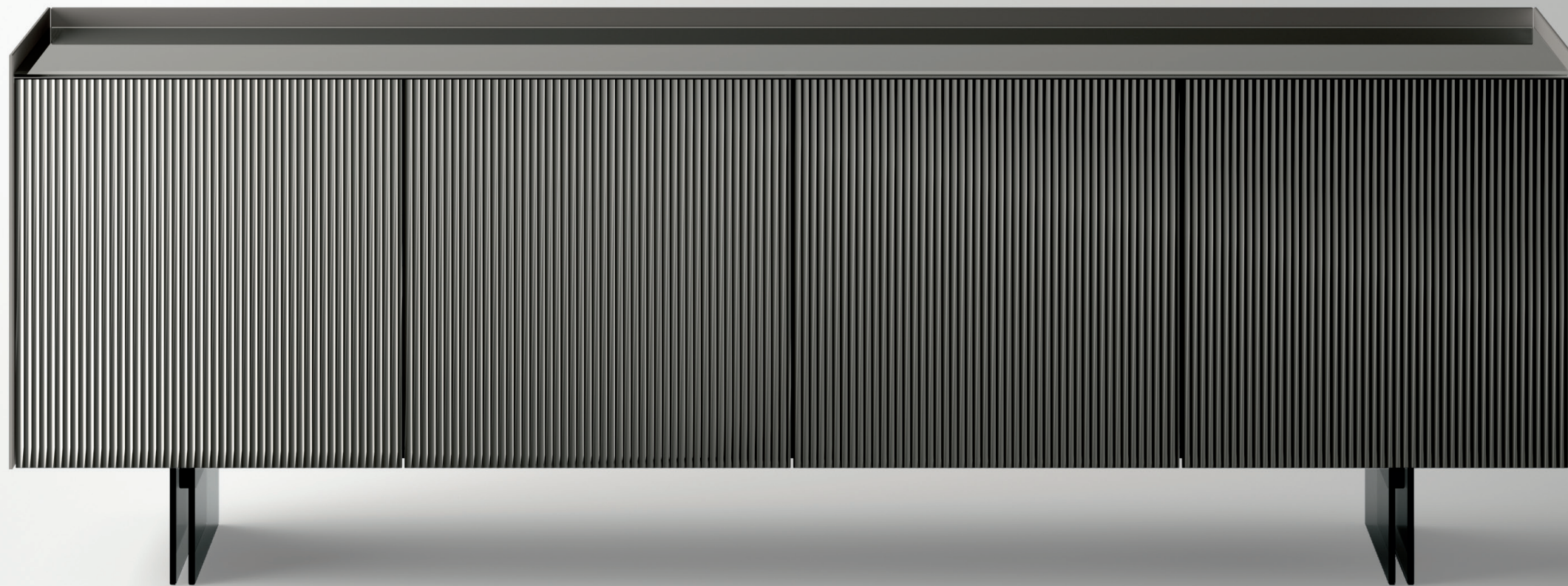

Ateara è una sedia dal design puro e lineare, pensata per essere reinterpretata e personalizzata in base al proprio gusto e stile abitativo. La scelta delle varianti in vetro fuso per i frontali, la rende testimone di una eccellenza costruttiva che unisce la cultura dell'arte vetraria alla moderna ricerca nel mondo del vetro.

Ateara is a sideboard of pure and linear design, thought to be interpreted and personalized according to personal taste and interior style. The choice of the fused glass versions for the frontals, make it the witness of a constructive excellence that merges the culture of glass art with the modern research in the glass world.



La ricercata combinazione di materiali nobili e sofisticati rendono questa media protagonista senza tempo dello spazio abitativo. Volumi essenziali dalle trame morbide che sorprendono per la loro delicata eleganza, esprimono leggerezza sospesi sulle basi di vetro.

The refined combination of noble and sophisticated materials makes this sideboard the timeless starting piece of the living space. Essential volumes of supple textures, surprising for their delicate elegance, convey lightness suspended on the glass bases.

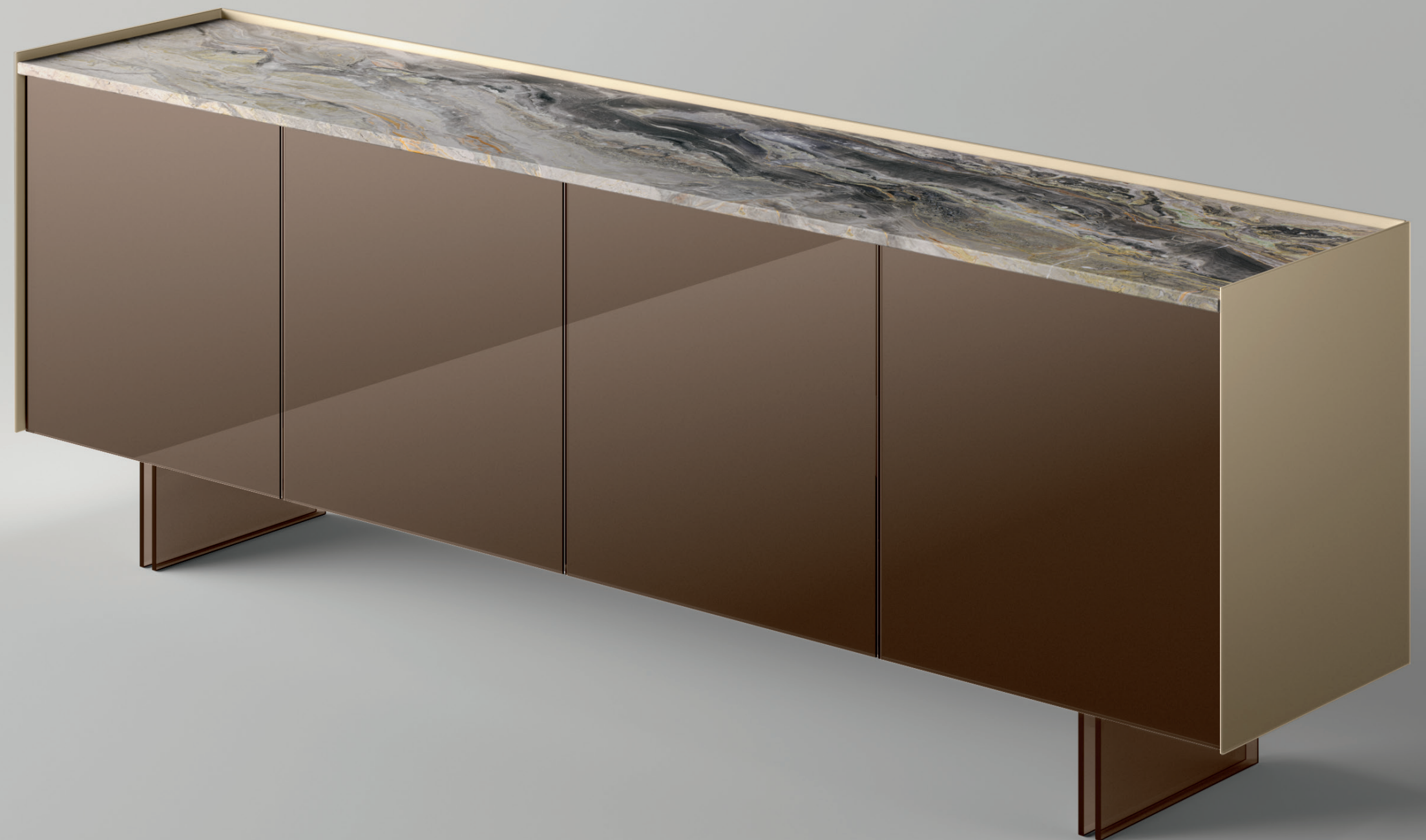

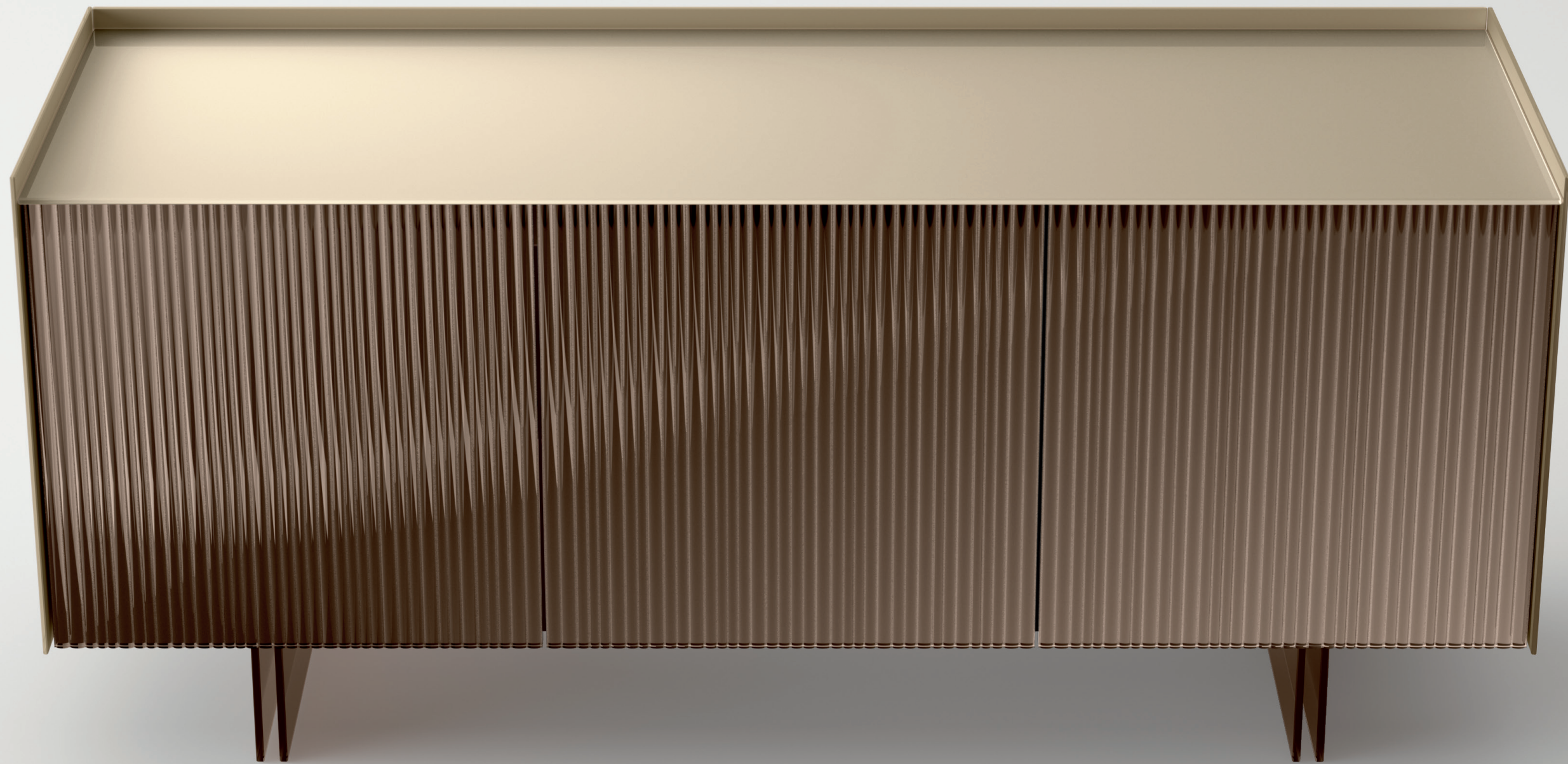

La madia prende corpo attraverso le texture e i colori dei vetri fusi che mettono in risalto la tridimensionalità del vetro, esaltandone la percezione tattile grazie alle rifrazioni della luce tipiche di questo materiale.

The sideboard takes shape through the texture and colours of the fused glass that emphasize the depth and character of the glass, enhancing the tactile perception because of the light refractions typical of this material.

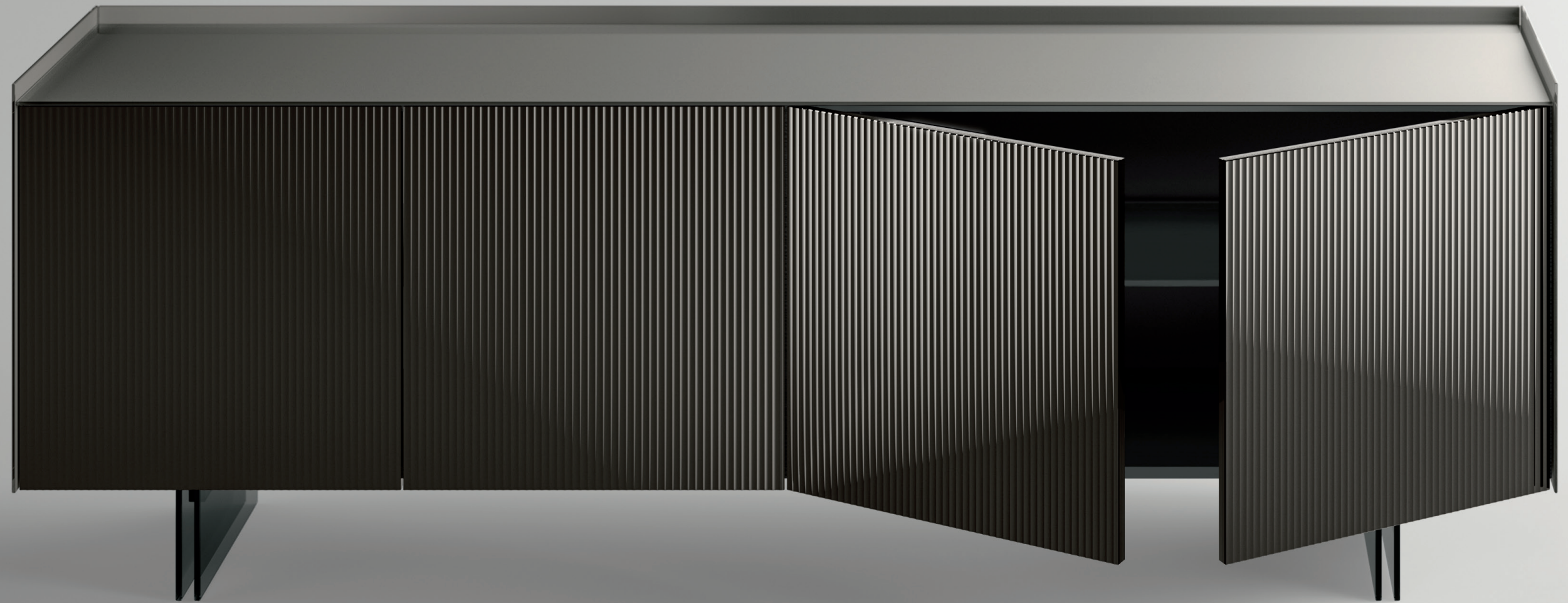

Aterea

Texture vetro fuso per ante / Fused glass texture for doors



Vetro T-Stripes specchio Glass T-Stripes mirror

Specchio Fumè e specchio bronzo
Smoked and bronze mirror

SEZIONE / SECTION



ELENCO COMPLETO DELLE FINITURE VEDI PAG. 124-125 / COMPLETE LIST OF FINISHES ON PAGES 124-125

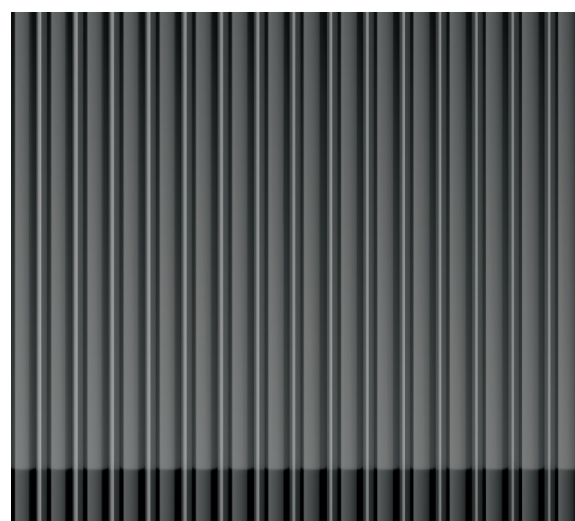

Vetro T-Bands specchio Glass T-Bands mirror

Specchio, specchio Fumè e specchio bronzo
Mirror, smoked and bronze mirror

SEZIONE / SECTION



ELENCO COMPLETO DELLE FINITURE VEDI PAG. 124-125 / COMPLETE LIST OF FINISHES ON PAGES 124-125

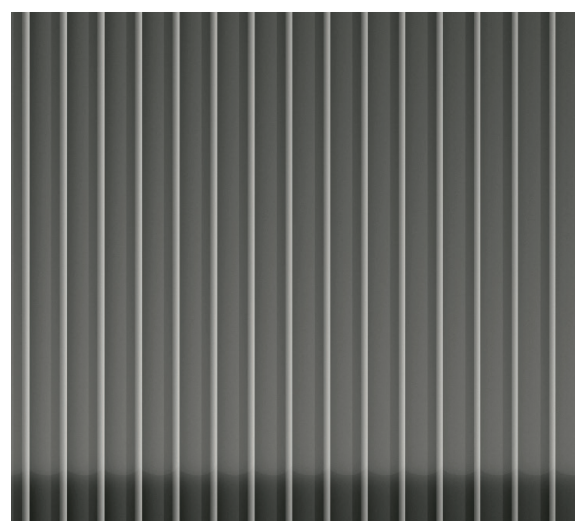

Vetro T-Bands retrolaccato Glass T-Bands backlacquered

Champagne e Titanio
Champagne and Titanium

SEZIONE / SECTION



ELENCO COMPLETO DELLE FINITURE VEDI PAG. 124-125 / COMPLETE LIST OF FINISHES ON PAGES 124-125

Aterea sideboard

design
Tonelli design studio

Info Tecniche / Technical Info

Madia con struttura interna in melaminico effetto tessuto grigio. Rivestimenti esterni in vetro retrovernicciato champagne o Titanio, extrachiaro (effetto lucido) o extrachiaro satinato (effetto opaco). Le ante battenti con apertura push pull, sono disponibili in molteplici finiture: specchio normale, specchio fumè o specchio bronzo, oppure in vetro T-Bands retrovernicciato champagne o Titanio, oppure in vetro T-Bands argentato specchio normale, specchio fumè o specchio bronzo, oppure in vetro fuso T-Stripes argentato, specchio fumè o specchio bronzo. Piedi in vetro saldato e due ripiani interni in vetro extrachiaro posizionabili in tre altezze. Il top può essere della stessa finitura dei rivestimenti esterni, oppure in ceramica o marmo. Optional kit illuminazione LED COB sotto la base con telecomando per l'accensione e la variazione dell'intensità luminosa.

Sideboard with internal structure in melamine with grey fabric effect. External coverings in champagne or Titanium backlacquered glass, extra-clear (polished effect) or frosted extra clear (matt effect). Swing doors with push-pull opening, available in numerous finishes: clear mirror, smoked or bronze mirror, or in glass T-Bands champagne or Titanium backlacquered, or in glass T-Bands clear mirror, smoked or bronze mirror, or in fused T-stripes smoked or bronze mirror. Feet in welded glass and two internal shelves in extra clear glass that can be positioned on three different heights. The top can be in the same finish of the external coverings, or in ceramic or marble. Optional LED COB lighting kit under the base with remote control for on/off switching and variation of light intensity.

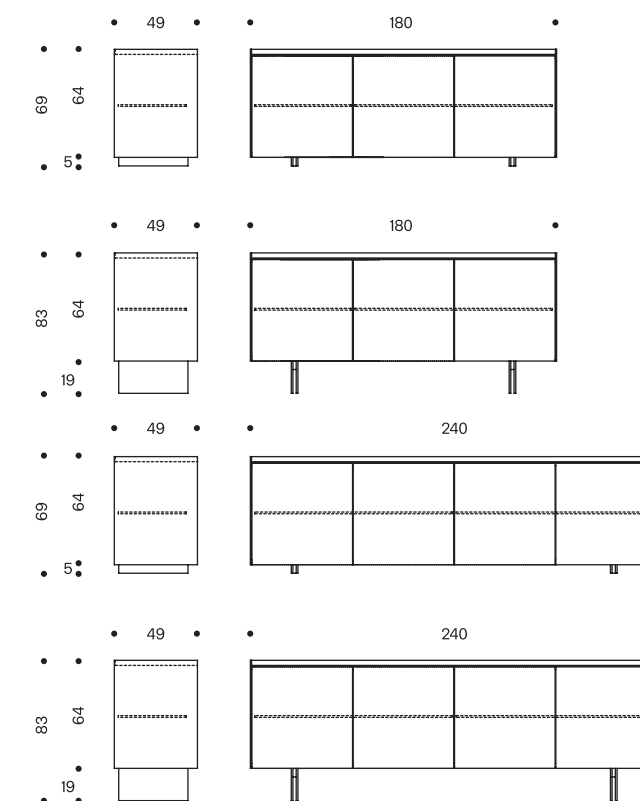

Split mirror

design
Francesco Forcellini

Split è una famiglia di specchi caratterizzata da un taglio verticale. All'interno di questo taglio due superfici specchiate inclinate riflettono lo spazio circostante e si riflettono tra loro, creando un gioco dinamico di riflessioni che si moltiplicano dando vita a nuove prospettive.

Split is a family of mirrors featuring a vertical cut. Inside this cut two inclined and mirrored surfaces reflect the surrounding space and each other, creating a dynamic interplay of reflections that multiply giving life to new perspectives.





Split non ha cornici e le sue proporzioni e bilanciamento formale sono date semplicemente dal taglio verticale dove gli specchi possono essere di colore diverso da quelli laterali, ottenendo così un effetto scenografico più deciso. Data la sua semplicità formale e monomaterialità, può essere facilmente inserito sia in contesti moderni, che più tradizionali.

Split has no frames and its proportions and formal balance are given simply by the vertical cut where the mirrors can be of different colour as those of the sides, gaining thus a more decisive scenic effect. Thanks to the formal simplicity and single material it can easily be fitted in modern ambiances and also more traditional ones.



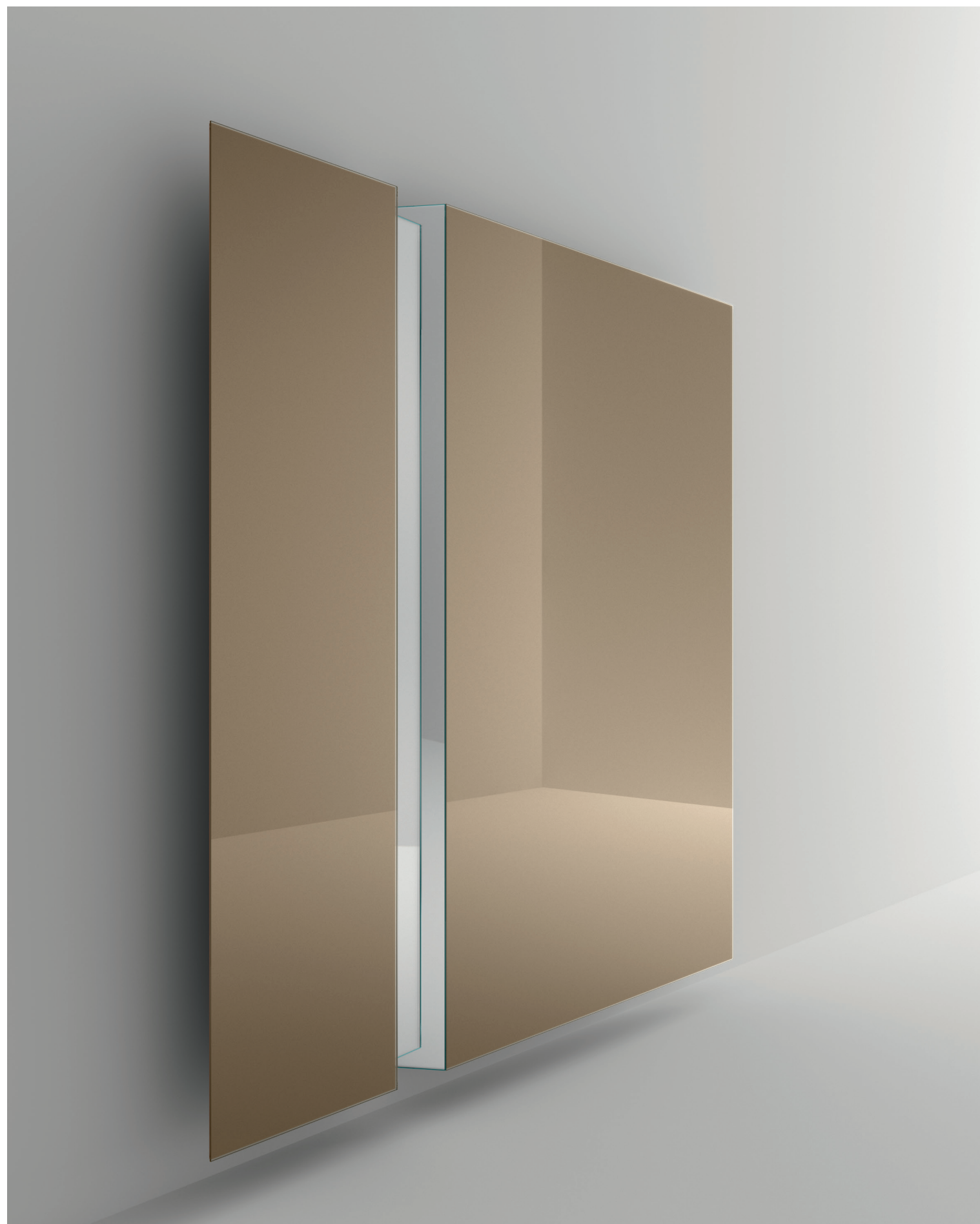

Split mirror

design
Francesco Forcellini

Info Tecniche / Technical Info

Specchio da parete disponibile in diverse forme e dimensioni con struttura in legno e lamiera verniciati nero. Il taglio centrale a "V" che separa i pannelli laterali è rivestito a specchio nelle finiture specchio normale, specchio fumè o specchio bronzo.

Wall mirror in different shapes and dimensions with black lacquered wooden structure and sheeting. The central "V" cut separating the side panels is covered in mirror available in clear mirror, smoked mirror or bronze mirror finish.

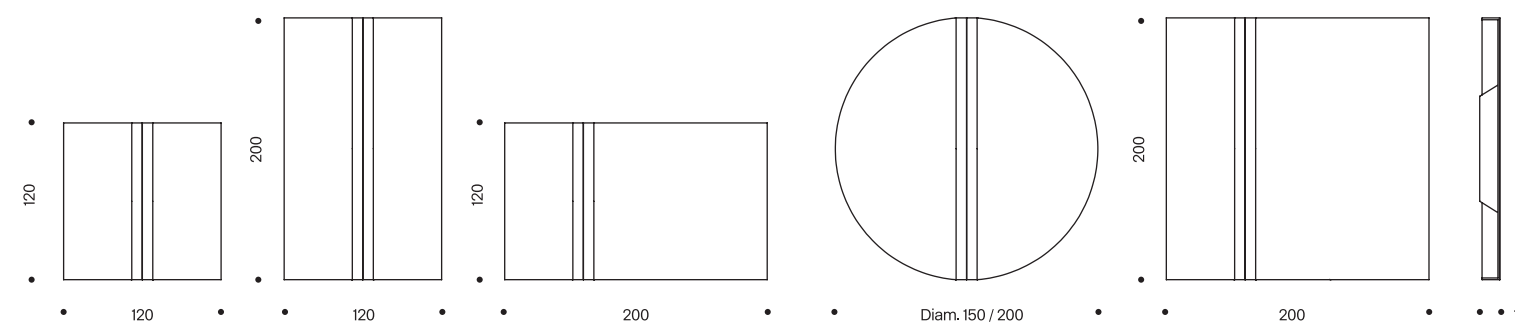



SC016

Soft Glass Divano / Sofa
Vetro extrachiaro, tessuto B 013
Extra clear glass, fabric B 013

Soft Glass Fianco divano / Side table
Vetro extrachiaro
Extra clear glass

Lilypad Tavolini / Coffee Tables
Vetro bronzo extrachiaro fumè,
vetro satinato, specchio
Bronze extra clear smoked glass,
frosted glass, mirror

Iris Specchio / Mirror
Specchio fumè
Smoked mirror

Quiller Libreria / Bookcase
Vetro extrachiaro
Extra clear glass



Soft Glass
sofa

design
Massimo Castagna



La collezione Soft Glass caratterizzata da linee contemporanee e confortevoli, si arricchisce di nuovi elementi e moduli pensati per offrire una maggiore libertà compositiva. Il nuovo side table completamente in vetro, permette di alternare i volumi e personalizzare lo spazio living. La leggerezza che contraddistingue il divano Soft Glass è messa in risalto dalle basi in vetro disponibili anche nelle varianti fumè e bronzo da abbinare con i tessuti delle parti imbottite.

Collection Soft Glass characterized by modern and comfortable lines gains new elements and modules thought to offer a greater compositional liberty. The new side table made entirely of glass, allows to alternate volumes and customize the living space. The lightness that distinguishes the sofa Soft Glass is enhanced by the glass bases available also in smoked and bronze finish to combine with the fabric of the upholstered parts





Soft Glass sofa

design
Massimo Castagna

Info Tecniche / Technical Info

Divano con struttura portante in legno listellare su basi in vetro stratificato e saldato spessore 20mm, finitura extrachiaro, fumè e bronzo. Sedute, schienali e braccioli imbottiti in poliuretano espanso a densità variabile rivestito con tessuto protettivo. Rivestimento esterno in tessuto sfoderabile con cucitura doppia a vista. Side table in vetro saldato, disponibile nelle finiture extrachiaro, fumè e bronzo, accostabile ai moduli divano. La varietà di elementi preconfigurati consente di elaborare un elevato numero di composizioni.

Sofa with supporting structure made of blockboard on stratified glass of 20mm, finish extra clear, smoked or bronze. Seatings, backrests and armrests in polyurethane foam with varying density covered with protective fabric. External lining in removable fabric with visible double stitching. Side table in welded glass available in extra clear, smoked or bronze finish, that can be put next to the sofa elements. The variety of preconfigured elements allows to develop a large number of compositions.

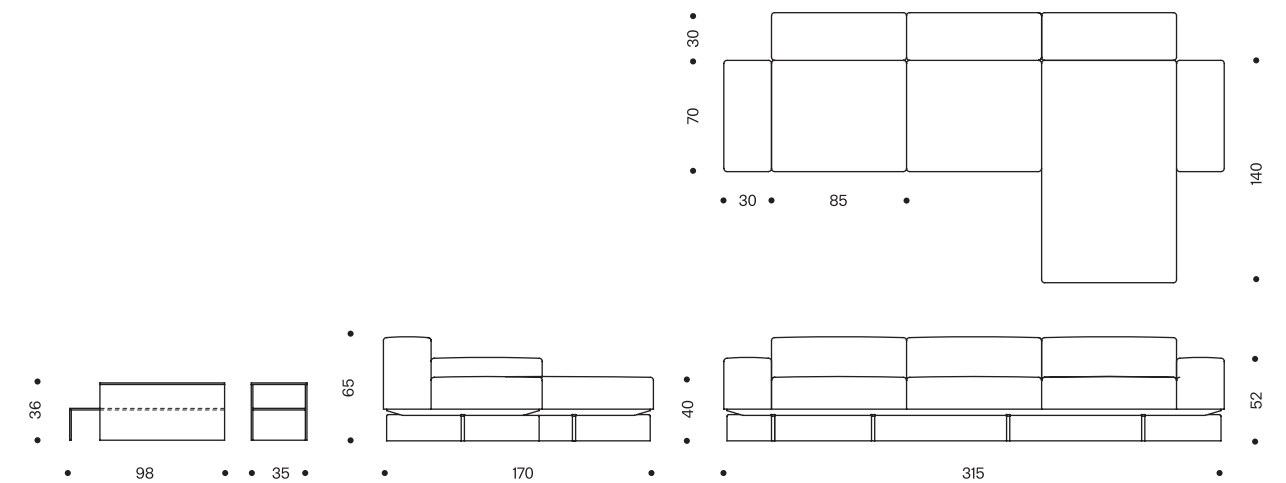

Lilypad coffee table

design
Karim Rashid

Piani sagomati di forma organica sono il segno distintivo di questo tavolino basso in vetro saldato, che gioca sull'alternanza delle finiture e delle linee armoniose. Le due diverse altezze consentono di accostare e sovrapporre i tavolini tra di loro per dare vita a composizioni creative e originali.

Organic shaped tops are the distinguishing trait of this cocktail table in welded glass, that plays with the alternance of the finishes and harmonic lines. The two different heights allow to combine and overlay the tables giving life to creative and original compositions.

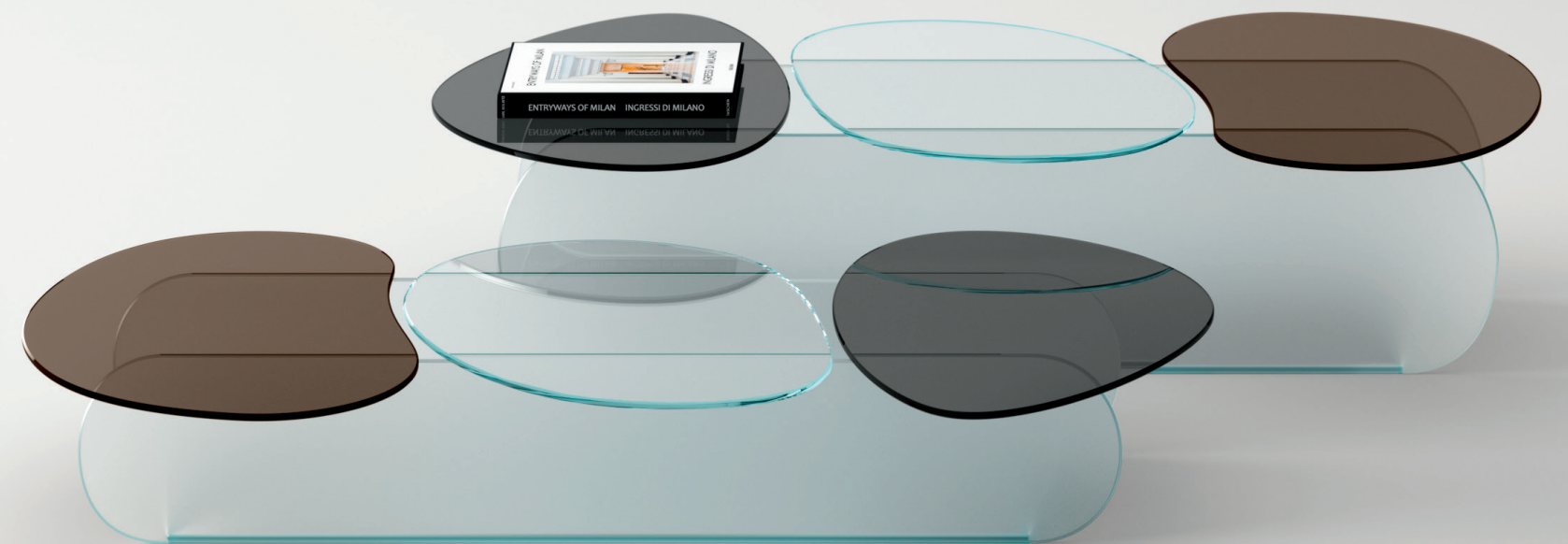



Lilypad coffee table

design
Karim Rashid

Info Tecniche / Technical Info

Tavolo basso in vetro saldato, con top di tre sagome diverse in vetro fumè, extrachiaro e bronzo. Fianchi verticali in vetro extrachiaro satinato e base in vetro a specchio. Disponibile in due diverse altezze per accostamenti e sovrapposizioni.

Cocktail table in welded glass with three differently shaped tops in smoked, extra clear and bronze glass. Vertical sides in extra clear frosted glass and mirrored glass base. Available in two different heights for combinations and overlaying.

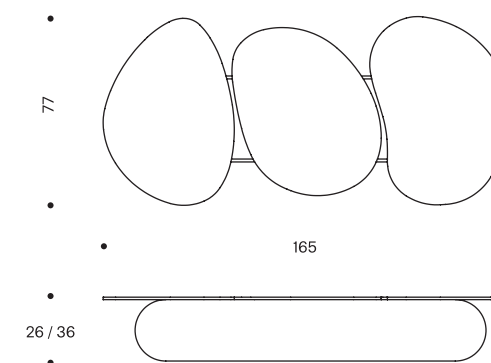

Iris
mirror

design
Tonelli design studio



Iris unisce la perfezione del segno alla magia del riflesso deformato dello spazio. Ricavato da una lastra unica di vetro curvato a caldo e argentato a mano, è un oggetto che cattura gli sguardi e domina l'ambiente.

Iris combines the perfection of the sign with the magic of the warped reflection of space. Obtained from a single slab of glass curved through heating and silvered by hand, it is an object that catches the eye and dominates the environment.





Iris mirror

design
Tonelli design studio

Info Tecniche / Technical Info

Specchi da parete in vetro curvo convesso, argentato a mano, disponibile nelle finiture specchio normale, specchio fumè o specchio bronzo. Eventuali imperfezioni sono ritenute caratteristiche peculiari di una lavorazione prettamente artigianale e autentica. Disponibile optional illuminazione LED COB 3000K con o senza telecomando per l'accensione e la regolazione dell'intensità luminosa.

Wall mirror in convex curved glass, silvered by hand, available in clear mirror, smoked mirror or bronze mirror. Eventual imperfections are considered peculiar characteristics of a strictly and authentic craftsmanship processing. Available with optional LED COB 3000K lighting with or without remote control for on/off function and regulation of the light intensity.

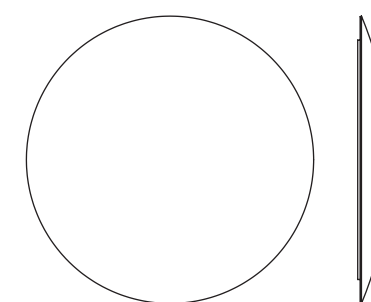

• Diam. 120 / 150 / 200 • • • 14 / 17 / 22

Quiller bookcase

design
Uto Balmoral

La lavorazione dei bordi bisellati tramite molatura rappresenta il dettaglio ricercato e distintivo della libreria Quiller. La luce naturale attraversando il vetro si trasforma in sorprendenti effetti caleidoscopici.

The bevelled edge process through grinding represents the refined and distinctive detail of the bookcase Quiller. The natural light that passes through the glass is transformed in surprising kaleidoscopic effects.



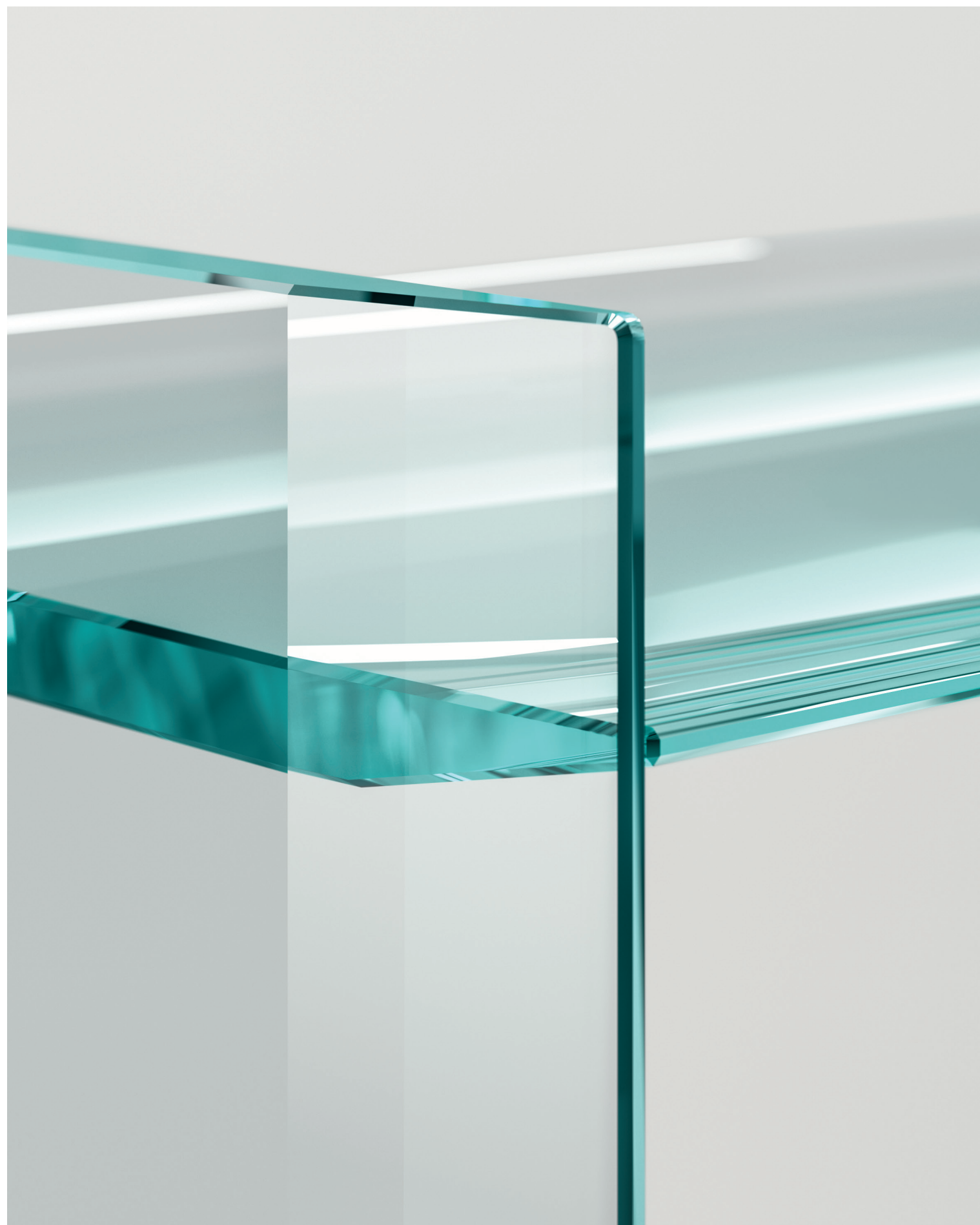

Quiller bookcase

design
Uto Balmoral

Info Tecniche / Technical Info

Libreria in vetro saldato extrachiaro spessore 15mm con bordi bisellati in profondità.

Bookcase in welded extra clear glass thickness 15mm with deep bevelling of the edges.

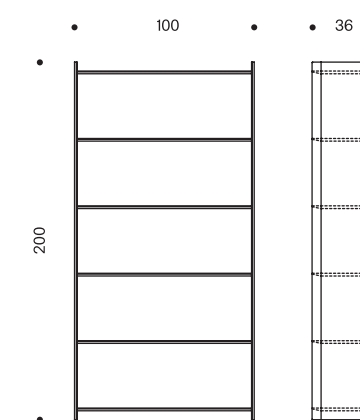



SC017

Pleat Tavolo / Table

Vetro extrachiaro, champagne metallizzato
Extra clear glass, metallic champagne

Mit Sedia / Chair

Canna di fucile, tessuto B 012
Gunmetal, fabric B 012

Noum Lampada / Lamp

Siberian ash
Siberian ash

Ateea Madia / Sideboard

Vetro satinato champagne,
T-Stripes specchio bronzo, vetro bronzo
Frosted champagne glass,
T-Stripes bronze mirror, bronze glass

Bands Specchio / Mirror

Specchio bronzo
Bronze mirror



Pleat
dining table

design
Massimo Castagna

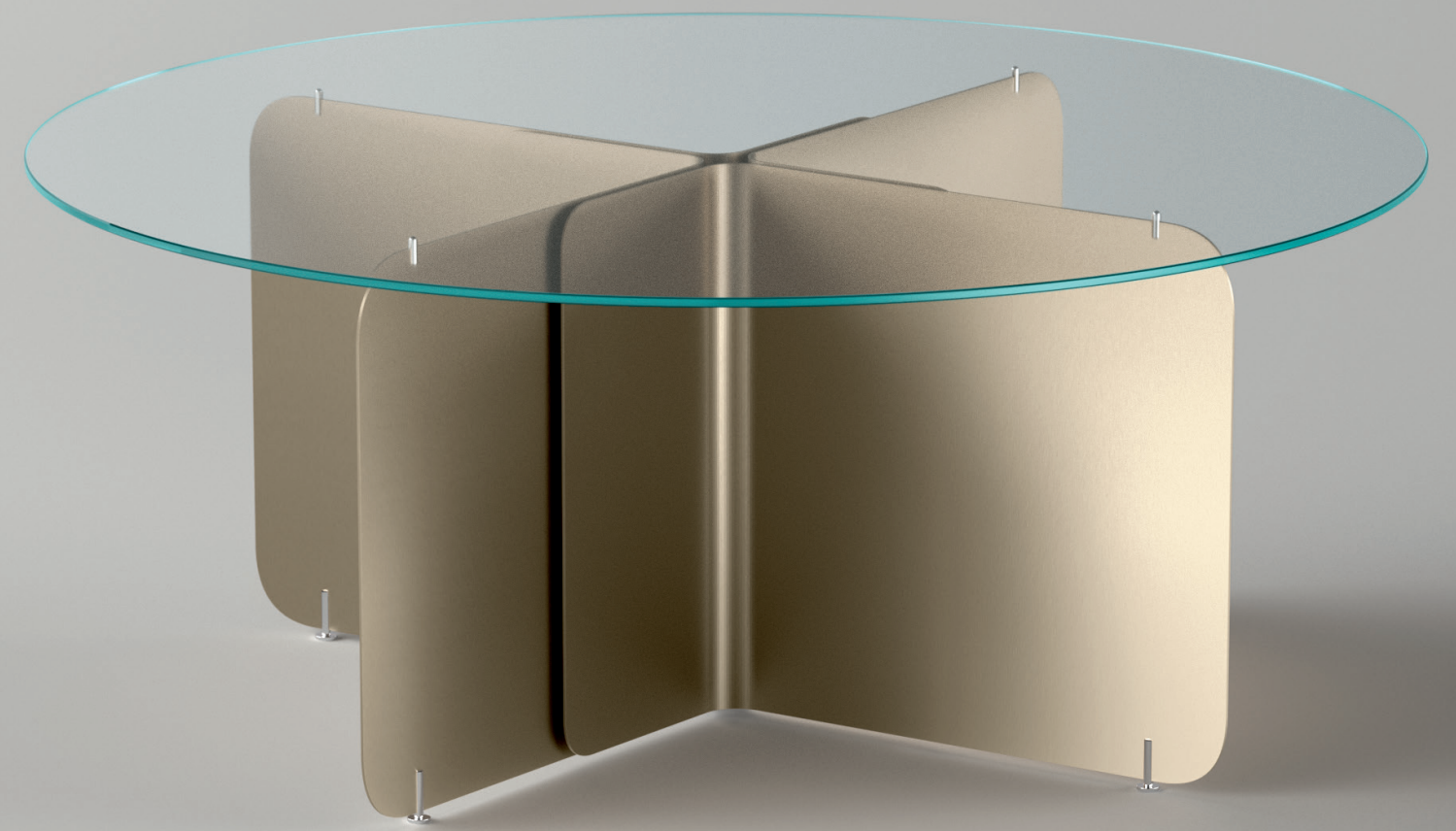

La scelta delle finiture di base e top unita all'armonia delle forme restituisce un tavolo dalle proporzioni perfette e dallo stile avvolgente. L'idea di un sottile foglio piegato si trasforma in una sensazione di stabilità e solidità.

The choice of the finishes for top and base together with the harmony of the shapes gives back a table of perfect proportions and enveloping style. The idea of a thin folded paper develops into a feeling of stability and strength.







Pleat dining table

design
Massimo Castagna

Info Tecniche / Technical Info

Tavolo con basamento centrale in metallo curvato, disponibile nelle finiture champagne metallizzato e Titanio spazzolato, o verniciato nero grafite opaco. Top in appoggio rettangolare, sagomato o rotondo in vetro extrachiaro, fumè o bronzo, oppure vetro fuso fumè o bronzo. Piedini a terra regolabili in altezza e perni di appoggio del top in metallo opaco.

Table with central base in curved metal, available in finishes metallic champagne and brushed Titanio, or matt graphite black lacquered. Rest on top rectangular, shaped or round in extra clear, smoked or bronze glass or in fused glass smoked or bronze. Small adjustable feet and supporting pins for the top in matt metal.

Piano / Top
200x110
220x110
240x110
260x110
280x110
300x110
320x120

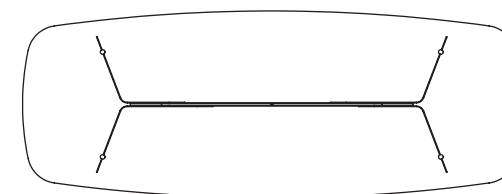

Piano / Top
200x100
220x100
240x100
260x100
280x100
300x100
320x120

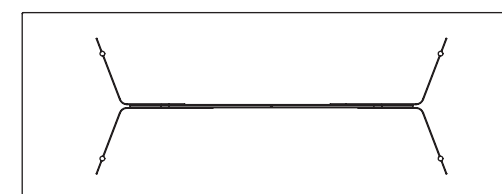

•
75
•

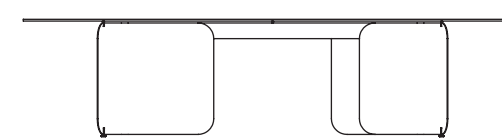

Piano / Top
diam. 140
diam. 160
diam. 180
diam. 200

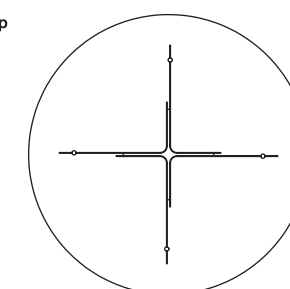

•
75
•

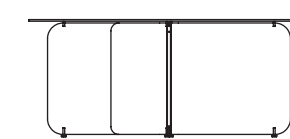

Mit chair

design
Massimo Castagna

L'eleganza stilistica combinata alla praticità e al comfort fanno di Mit una sedia che si integra a tavoli diversi per stile e forma, grazie anche all'ampia scelta di tessuti e finiture della struttura in metallo. La cura nella confezione delle parti imbottite e la perfezione di quelle in metallo, sono qualità distintive del prodotto.

The stylish elegance combined with practicality and comfort make Mit a chair that blends with tables of different style and shape, also because of the vast choice of fabrics and finishes of the metal structure. The care in the manufacturing of the upholstered parts and the perfection of those in metal are the distinctive traits of the product.







Mit chair

design
Massimo Castagna

Info Tecniche / Technical Info

Sedia con struttura in metallo curvato e saldato, nelle finiture cromo lucido, canna di fucile lucido oppure verniciata nero opaco, champagne o Titanio. Seduta e schienale sagomati imbottiti e rivestiti in tessuto, non sfoderabili. Su richiesta la seduta può essere sfoderabile.

Chair with structure in curved and welded metal, available in polished chrome, polished gunmetal finish or matt black, champagne or Titanio lacquered. Shaped seat and backrest upholstered and covered with fabric, not removable. Upon request the seating can be with removable cover.

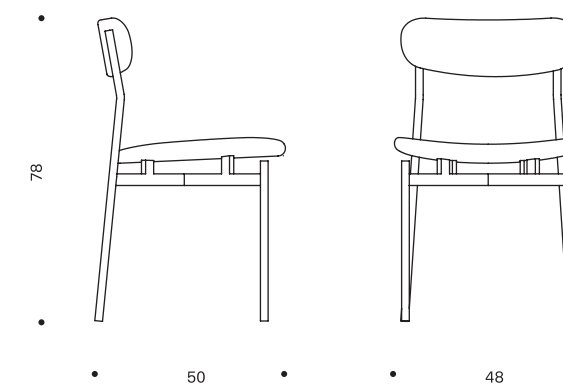

Bands mirror

design
angeletti ruzza design

Lo specchio centrale dalle linee morbide è racchiuso all'interno di una cornice lineare in vetro finemente lavorato e argentato. Per forma e finiture, Bands si colloca in diversi contesti della casa ed è pensato in abbinamento alla nuova madia Ateara.

The central mirror with smooth lines is enclosed by a linear glass frame finely crafted and silvered. For its shape and finishes, Bands adapts to different home areas and is particularly suited to be combined with the new sideboard Ateara.

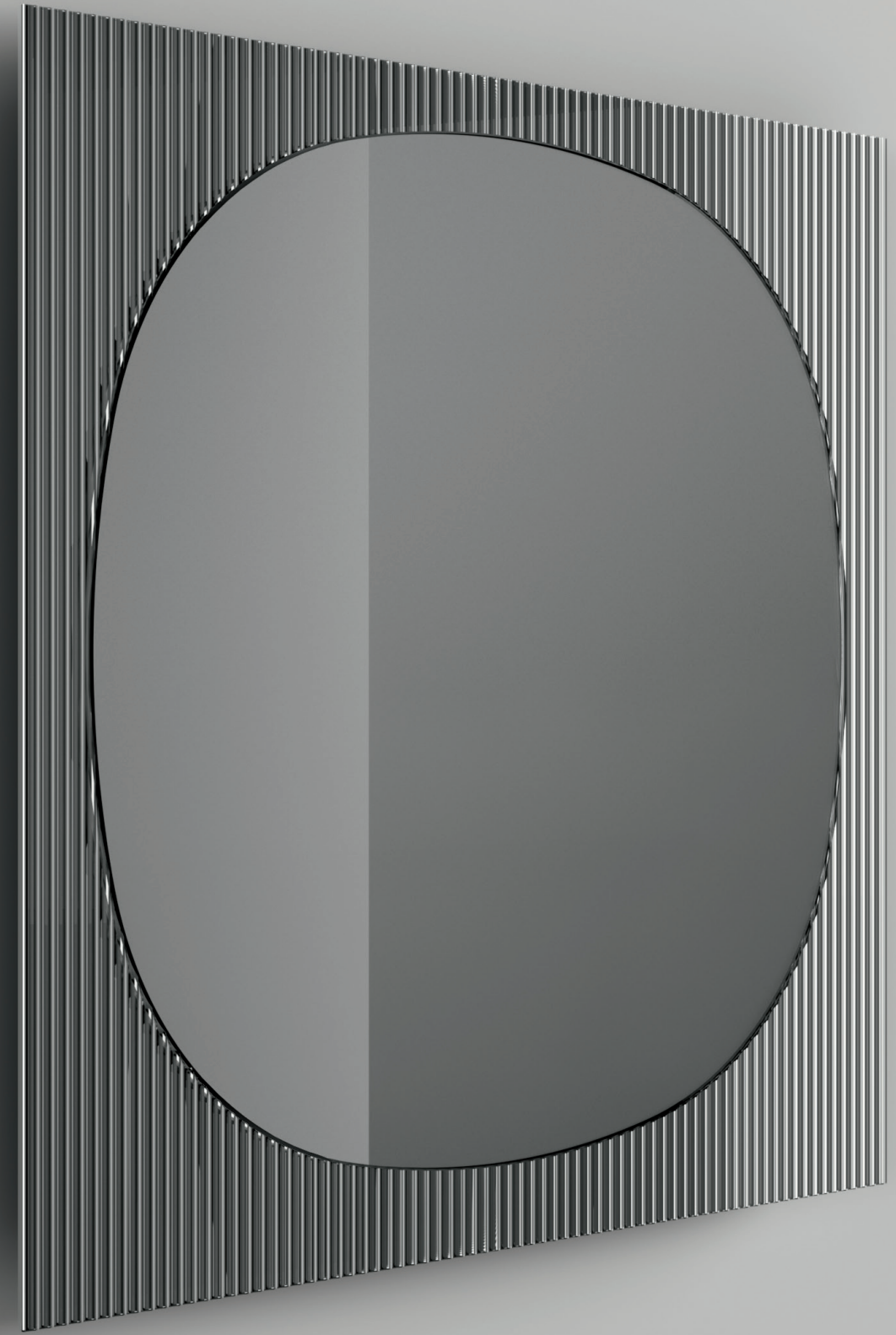



Bands mirror

design
angeletti ruzza design

Info Tecniche / Technical Info

Specchio da parete con cornice in vetro T-Bands specchiato, realizzato tramite l'unione di uno specchio ed un vetro cannettato. Disponibile in specchio, specchio fumè e specchio bronzo in diverse misure. La cornice è sempre della stessa finitura dello specchio centrale.

Wall mirror with frame in glass T-Bands mirror, made through the combination of a mirror and a reeds-like glass. Available in clear mirror, smoked mirror and bronze mirror, in different dimensions. The frame is always of the same finish as the central mirror.

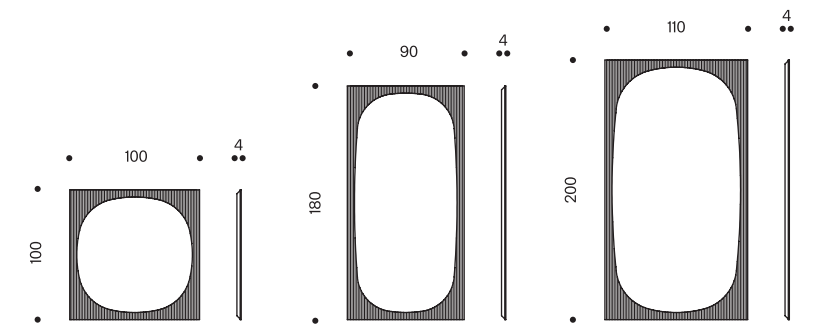



SC018

Farniente Tavolo / Table
Vetro bronzo, champagne metallizzato
Bronze glass, metallic champagne

Mit Sedia / Chair
Champagne metallizzato, tessuto P 304
Metallic champagne, fabric P 304

Hyperion Lampada / lamp
Champagne metallizzato,
vetro pyrex soffiato trasparente
Metallic champagne,
transparent blown pyrex glass

Iris Specchio / Mirror

Liber M Madia / Sideboard
Vetro extrachiaro, Eucalipto
Extra clear glass, Eucalipto



Farniente dining / coffee table

design
Giovanni Tommaso Garattoni

Un tavolo dal design senza tempo, dalla grande pulizia formale, nato da un'attenta ricerca delle proporzioni e degli equilibri. Farniente esalta la forza della tecnologia dell'incollaggio UV, procedimento che testimonia il know-how dell'azienda nella produzione di arredi in vetro.

Table of a timeless design, of extremely clean shape, born from attentive research of the proportions and balancing. Farniente exalts the strength of the UV-glueing technique, processing that witnesses the know-how of the company for the manufacturing of glass furniture.







Farniente dining / coffee table

design
Giovanni Tommaso Garattoni

Info Tecniche / Technical Info

Tavolo con piano in vetro temperato trasparente, extra chiaro, fumè o bronzo, con piastra in acciaio saldata e fissata alla base in metallo, disponibile nelle finitre cromo lucido, canna di fucile lucido o champagne metallizzato.

Table with tempered glass table top in transparent, extra clear, smoked or bronze finish, with metal plates glued to the top and fixed to the metal base, available in polished chrome, polished gunmetal or metallic champagne.

Piano / Top
diam. 70
diam. 90
diam. 110
diam. 120

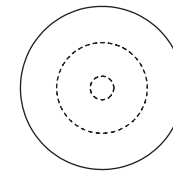

Piano / Top
diam. 90
diam. 110
diam. 120

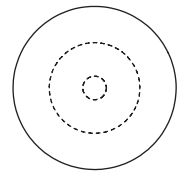

Piano / Top
90x90
110x110

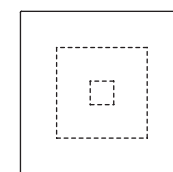

Piano / Top
90x90
110x110

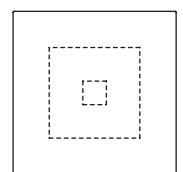

Piano / Top
130x70
150x80

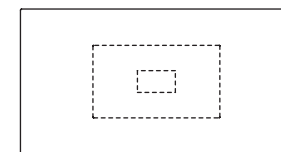

Piano / Top
130x70
150x80

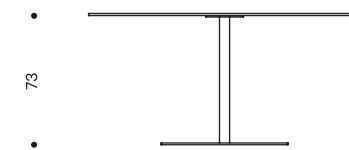
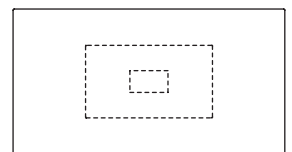

73

24,5 / 40

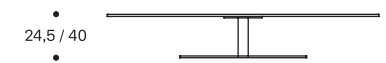

Liber M sideboard

design
Luca Papini

Liber M è la madia dell'ampia collezione di arredi in vetro saldato Liber. Il suo successo risiede nella leggerezza e trasparenza che caratterizza tutta la famiglia. Altro punto di forza è l'ampia personalizzazione, grazie alle diverse finiture di vetro e alla possibilità di aggiungere cassetti optional in legno o in pelle.

Liber M is the sideboard of the vast collection of furniture in welded glass Liber. Its success lies in the lightness and transparency that distinguishes the entire family. Other strong point is the vast customization thanks to different glass finishes and the possibility to add optional drawers in wood or leather.



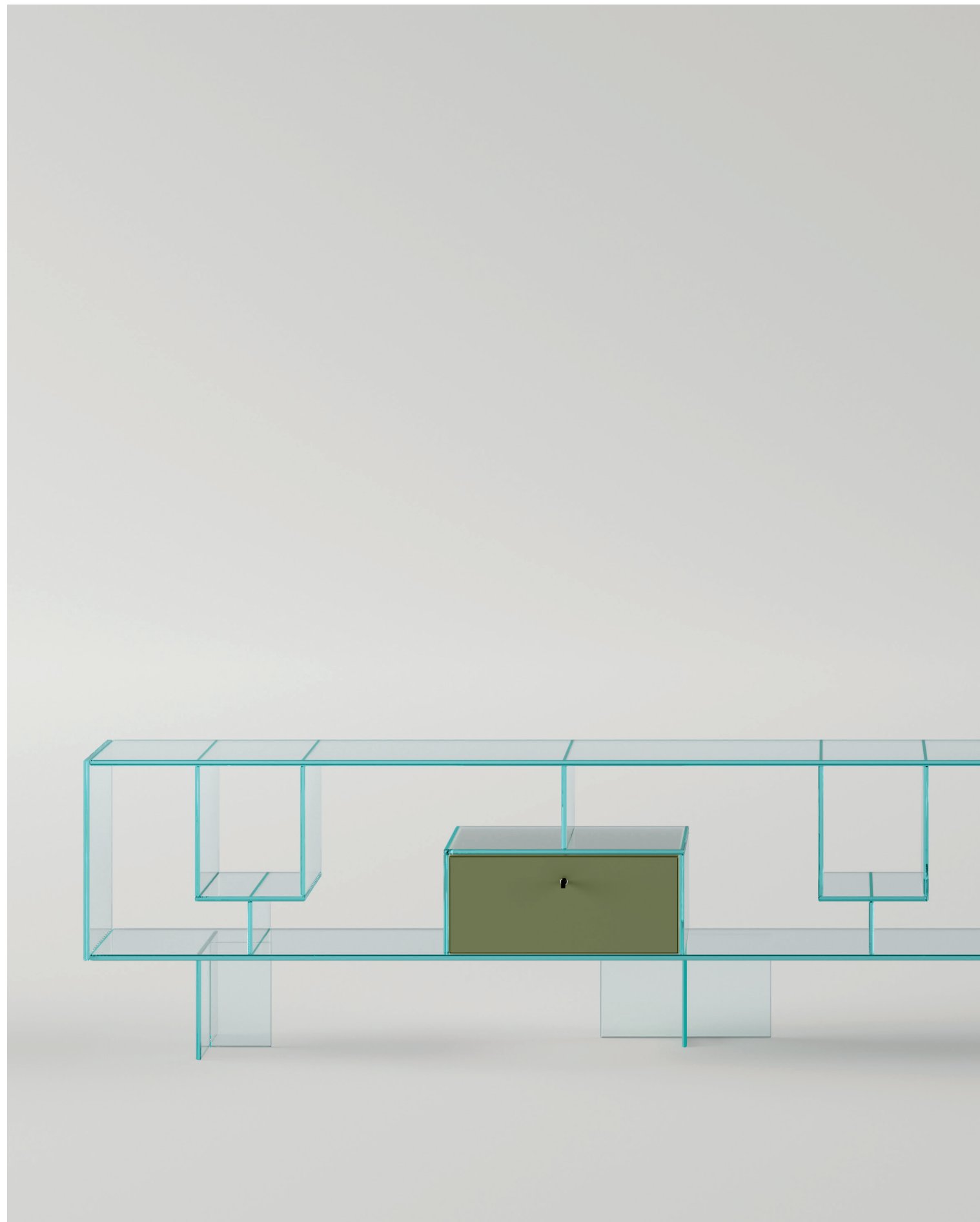

Liber M sideboard

design
Luca Papini

Info Tecniche / Technical Info

Madia in vetro saldato trasparente, extrachiaro o fumè in appoggio a basi in vetro h.20cm della stessa finitura. Optional cassetti laccati RAL o bianco con foro bifacciale o in legno Siberian Ash, Eucalipto o Noce Canaletto con maniglia in pelle o in finitura cuoio testa di moro con una maniglia.

Sideboard in welded glass transparent, extra clear or smoked, resting on glass bases h20cm of the same finish. Optional drawers white or RAL matt lacquered with double-sided hole or in wood, Siberian Ash, Eucalipto or Canaletto Walnut with leather handle or in dark leather finish with handle.

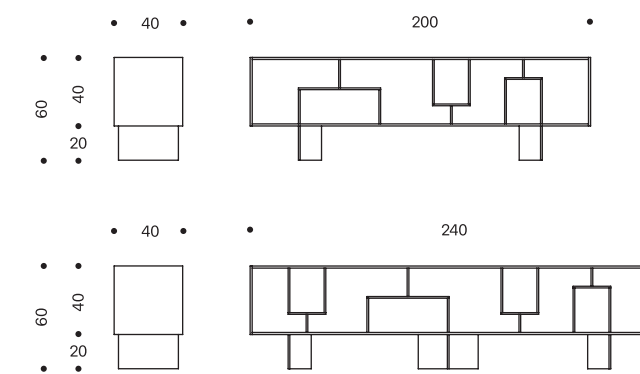



SC019

Penrose Desk Scrivania / Desk
Vetro extrachiaro
Extra clear glass

She Sedia / Chair
Nero, tessuto P 100
Black, fabric P 100

Hyperion Lampada / lamp
Oro lucido, vetro pyrex soffiato trasparente
Polished gold, transparent blown pyrex glass

Quiller Libreria / Bookcase
Vetro extrachiaro
Extra clear glass

Dekon Tavolini / Coffee Tables
Vetro extrachiaro
Extra clear glass

Soft Glass Divano / Sofa
Vetro fumè, tessuto P 107
Smoked glass, fabric P 107



Penrose
desk / console

design
Isao Hosoe con
Lucia Fontana e
Masaya Hashimoto

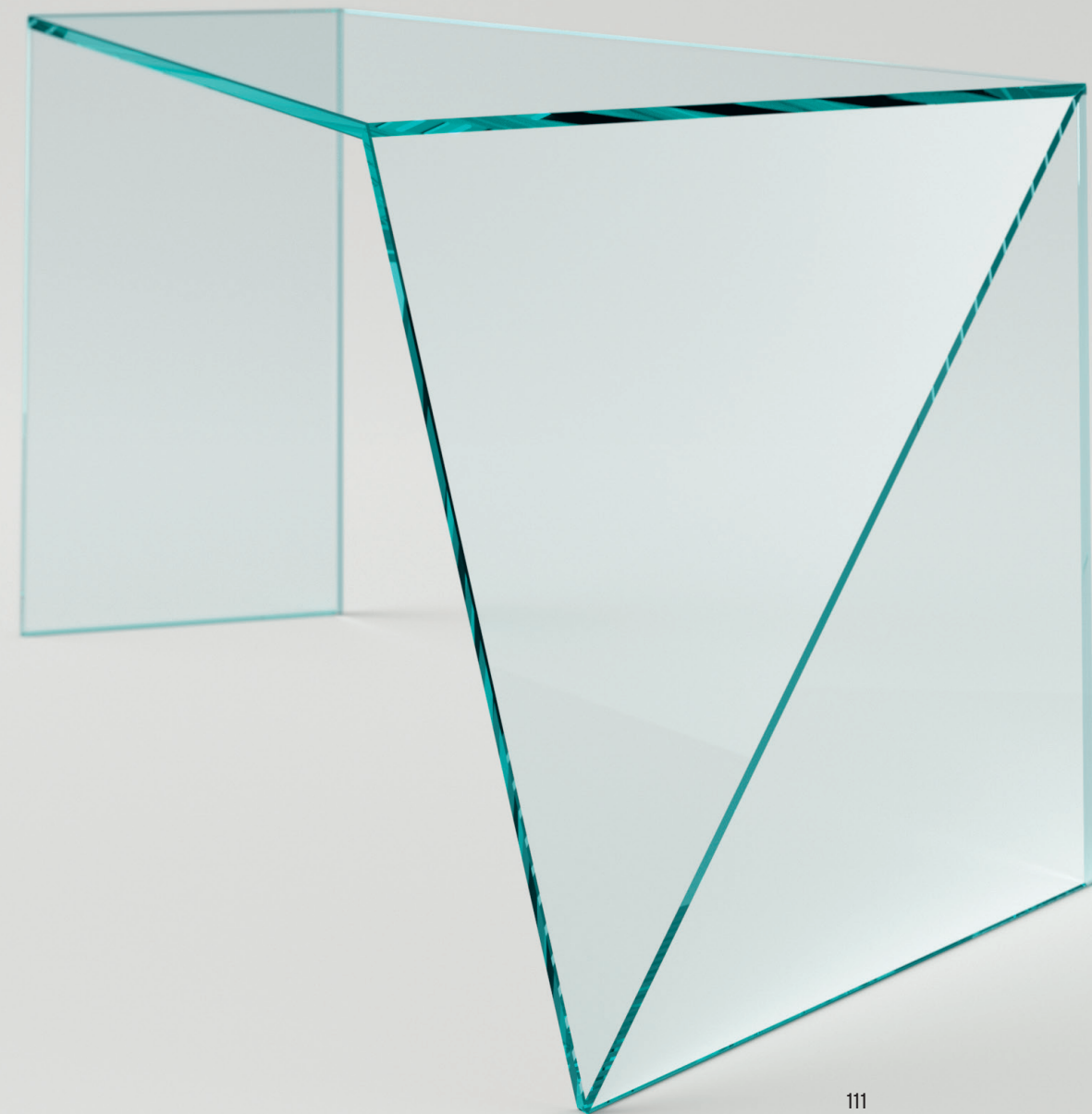



Scrivania e consolle pensate per lo studio e il lavoro in casa senza rinunciare alla bellezza e allo stile. Versatili e adatte a vari contesti di smart working, in cui il vetro è protagonista e funzionale. Penrose rappresenta la metafora estetica della sfida dell'uomo nel voler superare la natura e i suoi equilibri attraverso l'uso del vetro.

Desk and console designed for office and home work area without giving up on beauty and style. Versatile and suited for several smart working contexts, where the glass is the main protagonist and functional. Penrose represents the aesthetic metaphor that defies man in the desire to surpass nature and its equilibria through the use of glass.



Penrose desk / console

design
**Isao Hosoe con
Lucia Fontana e
Masaya Hashimoto**

Info Tecniche / Technical Info

Scrivania e console caratterizzata dalla struttura asimmetrica in vetro trasparente o extrachiaro, è capace di creare un equilibrio perfetto tra le lastre di vetro finemente tagliate.

Desk and console featuring an asymmetric structure in transparent or extra clear glass, it is able to create a perfect balance between the finely cut glass slabs.

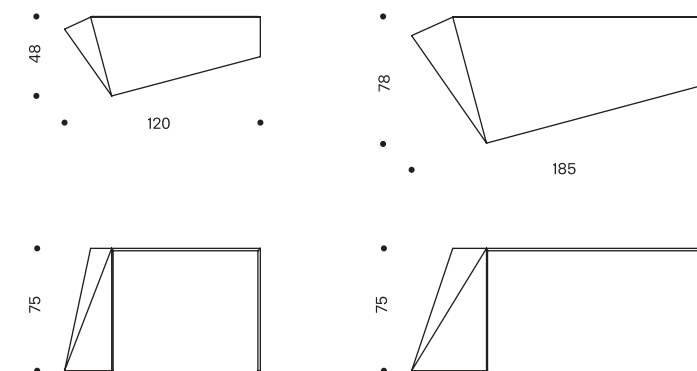

Dekon coffee table

design
Karim Rashid

Caratterizzato da forme futuristiche, adatte ad ambienti e arredamenti moderni e minimal, i particolari angoli di questo tavolo basso creano un piacevole effetto di continuità della superficie. Disponibile in vetro trasparente, extrachiaro o fumè, può essere posizionato in un verso o sottosopra generando due effetti visivi differenti.

Featuring futuristic shapes, suitable for modern and minimal environments and internal decors, the peculiar corners of this cocktail table create a pleasant continuous effect of the surface. Available in transparent, extra clear or smoked glass it can be placed in one direction or upside down generating two different visual effects.

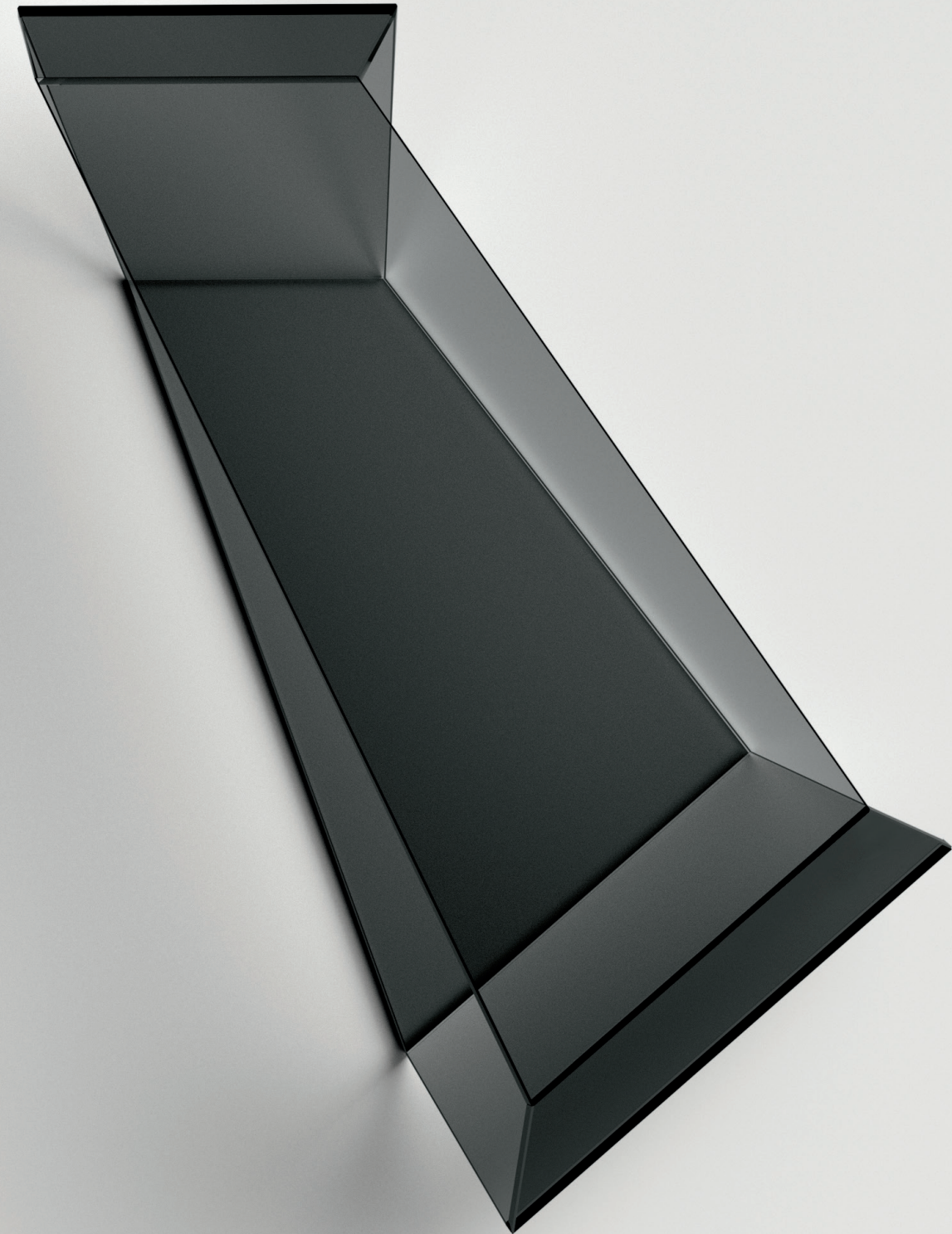



Dekon coffee table

design
Karim Rashid

Info Tecniche / Technical Info

Tavolo basso in vetro saldato trasparente, extrachiaro o fumè, dalla forma irregolare, dotato di piedini trasparenti per l'appoggio a terra.

Cocktail table in welded glass, transparent, extra clear or smoked, of irregular shape, provided with transparent feet.

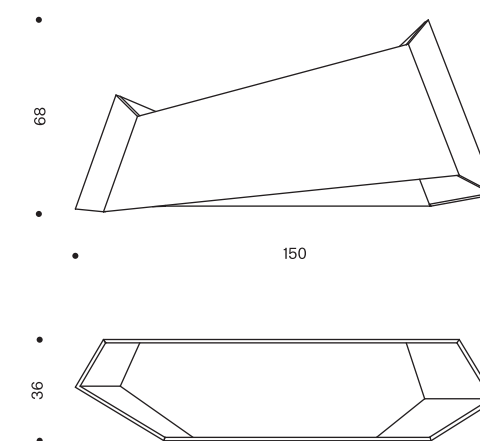

Materials collection

Collezione
materiali

Materials index

Indice materiali

Vetro **122**
Glass

Specchio **122**
Mirror

Legno **123**
Wood

Metallo **123**
Metal

Aterea **124**

Finiture **125**
Finishing

Mit chair **126**

Soft Glass sofa **127**

Tessuto
Textile

Collezione materiali Materials collection

Vetro / Glass

Extrachiaro
Extra clear



Fumè
Smoked



Bronzo
Bronze



Fumè fuso
Smoked fused



Bronzo fuso
Bronze fused



T-Stripes Fumè
Smoked T-Stripes



T-Stripes Bronzo
Bronze T-Stripes



T-Squares Fumè
Smoked T-Squares

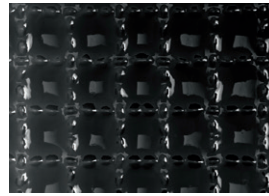

T-Squares Bronzo
Bronze T-Squares

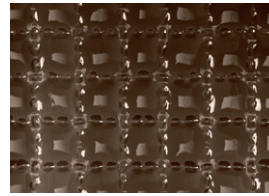

Specchio / Mirror

Specchio
Mirror



Fumè
Smoked



Bronzo
Bronze



Collezione materiali Materials collection

La riproduzione delle finiture su carta può riportare leggere differenze cromatiche rispetto agli originali. Finishes reproductions on paper can differ slightly from the original ones.

Legno / Wood

Siberian Ash



Eucalipto

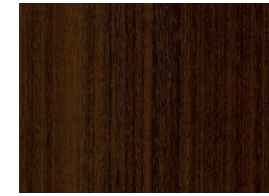

Rovere Naturale
Natural Oak



Noce canaletto
Canaletto walnut



Metallo / Metal

Cromo / Chrome



FINITURA LUCIDA
POLISHED FINISHING

Canna di fucile / Gunmetal



FINITURA LUCIDA
POLISHED FINISHING

Finiture su metallo / Metal finishing

Titanio

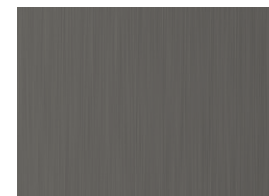

FINITURA SPAZZOLATA
BRUSHED FINISHING

Champagne



FINITURA METALLIZZATA
METALLIZED FINISHING

Aterea sideboard

finiture / finishing

Rivestimenti esterni fianchi e schienale / External coverings sides and backpanel

Vetro Extrachiaro
retrolaccato champagne
Backlacquered champagne
extra clear glass



Vetro Extrachiaro
retrolaccato Titanio
Backlacquered Titanio
extra clear glass

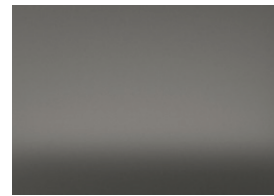

Vetro Extrachiaro satinato
retrolaccato champagne
Backlacquered champagne
extra clear frosted glass



Vetro Extrachiaro satinato
retrolaccato Titanio
Backlacquered Titanio
extra clear frosted glass



Ante / Doors

Specchio
Mirror



Specchio fumè
Smoked mirror



Specchio bronzo
Bronze mirror



Vetro T-Bands
retrolaccato champagne
T-Bands backlacquered
champagne glass



Vetro T-Bands
retrolaccato Titanio
T-Bands backlacquered
Titanio glass

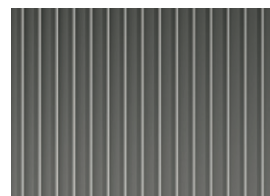

Vetro T-Stripes specchio fumè
T-Stripes smoked mirror glass



Vetro T-Stripes specchio bronzo
T-Stripes bronze mirror glass



Vetro T-Bands specchio
T-Bands mirror glass



Vetro T-Bands specchio fumè
T-Bands smoked mirror glass



Vetro T-Bands specchio bronzo
T-Bands bronze mirror glass



Piedi / Feet

Vetro extrachiaro
Extraclear glass



Vetro fumè
Smoked glass



Vetro bronzo
Bronze glass



Struttura / Structure

Melaminico tessuto grigio
Melamine grey fabric



Aterea sideboard

finiture / finishing

La riproduzione delle finiture su carta può riportare leggere differenze cromatiche rispetto agli originali. / Finishes reproductions on paper can differ slightly from the original ones.

Riporto top / Countertop

Vetro Extrachiaro
retrolaccato champagne
Backlacquered champagne
extra clear glass



Vetro Extrachiaro
retrolaccato Titanio
Backlacquered Titanio
extra clear glass

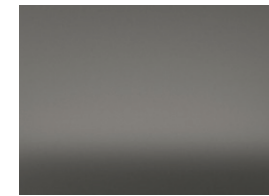

Vetro Extrachiaro satinato
retrolaccato champagne
Backlacquered champagne
extra clear frosted glass



Vetro Extrachiaro satinato
retrolaccato Titanio
Backlacquered Titanio
extra clear frosted glass



Marmo / Marble Tropikal storm
FINITURA SPAZZOLATA
BRUSHED FINISHING



Marmo / Marble Arabescato
Orobico Gold
FINITURA SPAZZOLATA
BRUSHED FINISHING

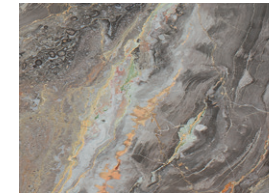

Marmo / Marble Domus White
FINITURA SPAZZOLATA
BRUSHED FINISHING

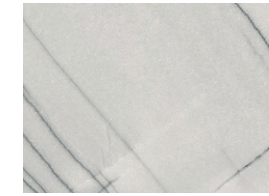

Marmo / Marble Nero Marquina
FINITURA SPAZZOLATA
BRUSHED FINISHING



Marmo / Marble Bianco Carrara
FINITURA SPAZZOLATA
BRUSHED FINISHING



Marmo / Marble Sahara Noir
FINITURA SPAZZOLATA
BRUSHED FINISHING

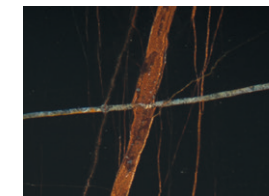

Ceramica / Ceramic Sahara Noir
FINITURA LUCIDA O BOCCIARDATA
POLISHED OR BOCCIARDATA
FINISHING



Ceramica / Ceramic Pietra Grey
FINITURA LUCIDA O OPACA
POLISHED OR MATT FINISHING



Ceramica / Ceramic Calacatta
Oro Venato
FINITURA LUCIDA
POLISHED FINISHING



Ceramica / Ceramic Noir Desir
FINITURA LUCIDA O OPACA
POLISHED OR MATT FINISHING

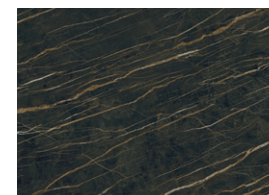

Ceramica / Ceramic Pietra di
Savoia Antracite
FINITURA BOCCIARDATA
BOCCIARDATA FINISHING

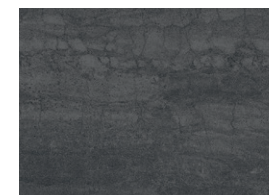

Ceramica / Ceramic Emperador
FINITURA LUCIDA O OPACA
POLISHED OR MATT FINISHING

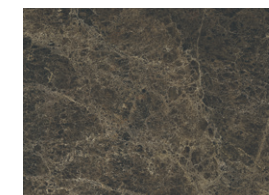

Mit chair / Soft Glass sofa
tessuto / textile

Tessuto / Textile B



Tessuto / Textile C



Mit chair / Soft Glass sofa
tessuto / textile

La riproduzione delle finiture su carta può riportare leggere differenze cromatiche rispetto agli originali. / Finishes reproductions on paper can differ slightly from the original ones.

Tessuto / Textile F

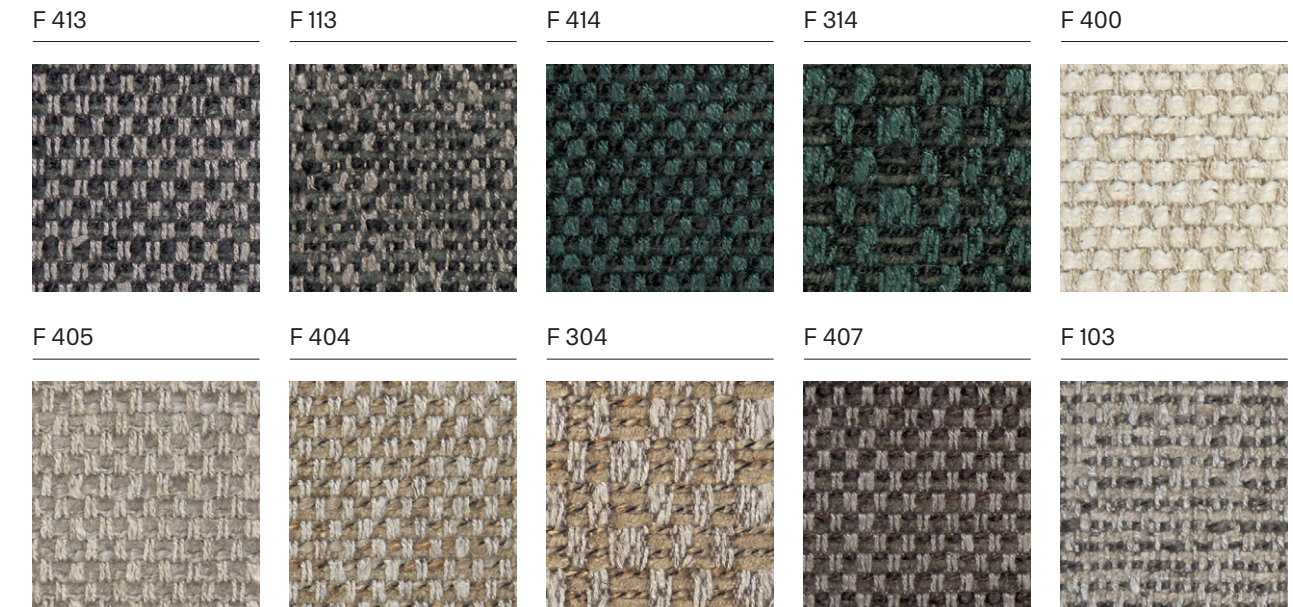

Tessuto / Textile P



Tonellidesign

Tonelli Design

T.D. Srl
via Casali 40/42
61122 - Pesaro (PU) Italy
tel. +39 0721 481172
www.tonellidesign.it
info@tonellidesign.it
export@tonellidesign.it

-  Tonelli design
-  Tonelli_Design
-  tonelli-design
-  Tonelli Design-Official

The New Modernism

art direction

Massimo Castagna / AD Architettura

digital images

Garage121

graphic design

Enrico Severi Design

post production

MIC Studio

print

Gruppo Leardini

Published April 2024

Tonelli Design / All rights reserved

Tonellidesign